

N-channel 100 V, 0.0036 Ω typ., 110 A, STripFET™ F7 Power MOSFET in a TO-220 package

Datasheet - production data

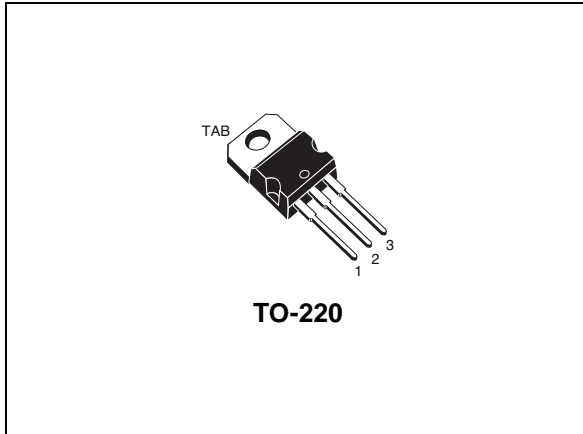
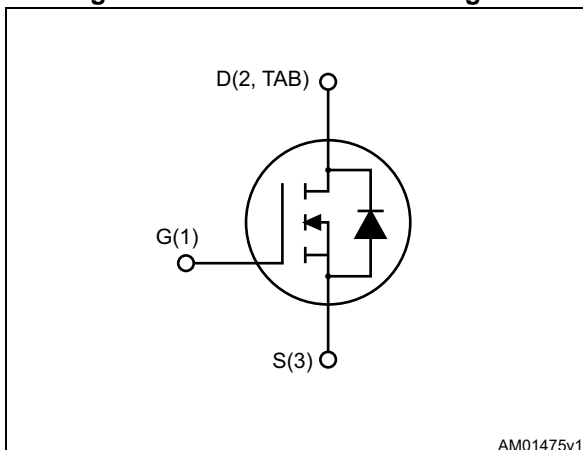

Figure 1. Internal schematic diagram



Features

Order code	V _{DS}	R _{DS(on)max}	I _D	P _{TOT}
STP15810	100 V	0.0042 Ω	110 A	250 W

- 100% avalanche tested
- Ultra low on-resistance

Applications

- Switching applications

Description

This N-channel Power MOSFETs utilizes STripFET™ F7 technology with an enhanced trench gate structure that results in very low on-state resistance, while also reducing internal capacitance and gate charge for faster and more efficient switching.

Table 1. Device summary

Order code	Marking	Package	Packaging
STP15810	15810	TO-220	Tube

Contents

1	Electrical ratings	3
2	Electrical characteristics	4
2.1	Electrical characteristics (curves)	6
3	Test circuits	8
4	Package mechanical data	9
5	Revision history	12

1 Electrical ratings

Table 2. Absolute maximum ratings

Symbol	Parameter	Value	Unit
V_{DS}	Drain-source voltage	100	V
V_{GS}	Gate- source voltage	± 20	V
I_D	Drain current (continuous) at $T_C = 25\text{ }^\circ\text{C}$	110	A
I_D	Drain current (continuous) at $T_C = 100\text{ }^\circ\text{C}$	110	A
$I_{DM}^{(1)}$	Drain current (pulsed) $T_C = 25\text{ }^\circ\text{C}$	440	A
P_{TOT}	Total dissipation at $T_C = 25\text{ }^\circ\text{C}$	250	W
$E_{AS}^{(2)}$	Single pulse avalanche energy	495	mJ
T_J	Operating junction temperature	-55 to 175	$^\circ\text{C}$
T_{stg}	Storage temperature		$^\circ\text{C}$

1. Pulse width is limited by safe operating area

2. Starting $T_J=25\text{ }^\circ\text{C}$, $I_D=30\text{ A}$, $V_{DD}=50\text{ V}$

Table 3. Thermal data

Symbol	Parameter	Value	Unit
$R_{thj-case}$	Thermal resistance junction-case max	0.6	$^\circ\text{C/W}$
$R_{thj-amb}$	Thermal resistance junction-ambient max	62.5	$^\circ\text{C/W}$

2 Electrical characteristics

($T_C = 25\text{ °C}$ unless otherwise specified)

Table 4. On /off states

Symbol	Parameter	Test conditions	Min.	Typ.	Max.	Unit
$V_{(BR)DSS}$	Drain-source breakdown voltage	$V_{GS} = 0, I_D = 250\ \mu A$	100			V
I_{DSS}	Zero gate voltage drain current	$V_{GS} = 0, V_{DS} = 100\ V$			1	μA
		$V_{GS} = 0, V_{DS} = 100\ V, T_C = 125\text{ °C}$			100	μA
I_{GSS}	Gate-body leakage current	$V_{DS} = 0, V_{GS} = +20\ V$			100	nA
$V_{GS(th)}$	Gate threshold voltage	$V_{DS} = V_{GS}, I_D = 250\ \mu A$	2.5		4.5	V
$R_{DS(on)}$	Static drain-source on-resistance	$V_{GS} = 10\ V, I_D = 55\ A$		0.0036	0.0042	Ω

Table 5. Dynamic

Symbol	Parameter	Test conditions	Min.	Typ.	Max.	Unit
C_{iss}	Input capacitance	$V_{DS} = 55\ V, f = 1\ MHz, V_{GS} = 0$	-	8115	-	pF
C_{oss}	Output capacitance		-	1510	-	pF
C_{riss}	Reverse transfer capacitance		-	67	-	pF
Q_g	Total gate charge	$V_{DD} = 55\ V, I_D = 90\ A, V_{GS} = 10\ V$ (see Figure 14)	-	117	-	nC
Q_{gs}	Gate-source charge		-	47	-	nC
Q_{gd}	Gate-drain charge		-	26	-	nC

Table 6. Switching times

Symbol	Parameter	Test conditions	Min.	Typ.	Max.	Unit
$t_{d(on)}$	Turn-on delay time	$V_{DD} = 50\ V, I_D = 55\ A, R_G = 4.7\ \Omega, V_{GS} = 10\ V$ (see Figure 13)	-	33	-	ns
t_r	Rise time		-	57	-	ns
$t_{d(off)}$	Turn-off delay time		-	72	-	ns
t_f	Fall time		-	33	-	ns

Table 7. Source drain diode

Symbol	Parameter	Test conditions	Min.	Typ.	Max.	Unit
I_{SD}	Source-drain current		-		110	A
$I_{SDM}^{(1)}$	Source-drain current (pulsed)		-		440	A
$V_{SD}^{(2)}$	Forward on voltage	$I_{SD} = 110 \text{ A}$, $V_{GS} = 0$	-		1.2	V
t_{rr}	Reverse recovery time	$I_{SD} = 110 \text{ A}$, $di/dt = 100 \text{ A}/\mu\text{s}$ $V_{DD} = 80 \text{ V}$, $T_J = 150 \text{ }^\circ\text{C}$ (see Figure 15)	-	70		ns
Q_{rr}	Reverse recovery charge		-	165		nC
I_{RRM}	Reverse recovery current		-	4.7		A

1. Pulse width limited by safe operating area
2. Pulsed: pulse duration = 300 μs , duty cycle 1.5%.

2.1 Electrical characteristics (curves)

Figure 2. Safe operating area

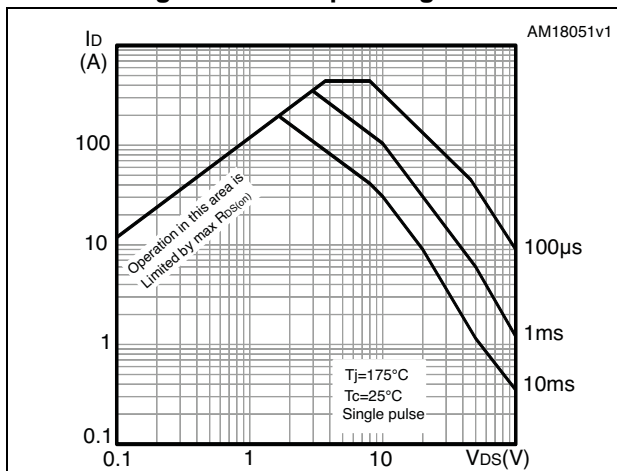

Figure 3. Thermal impedance

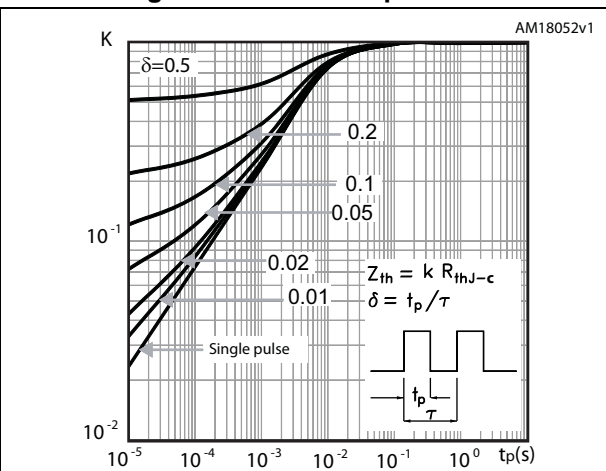

Figure 4. Output characteristics

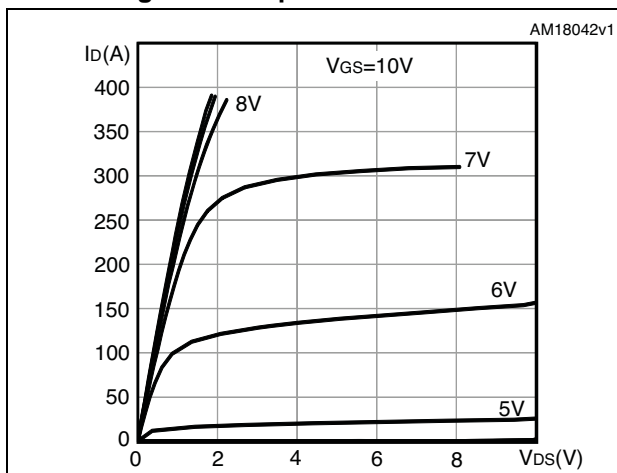

Figure 5. Transfer characteristics

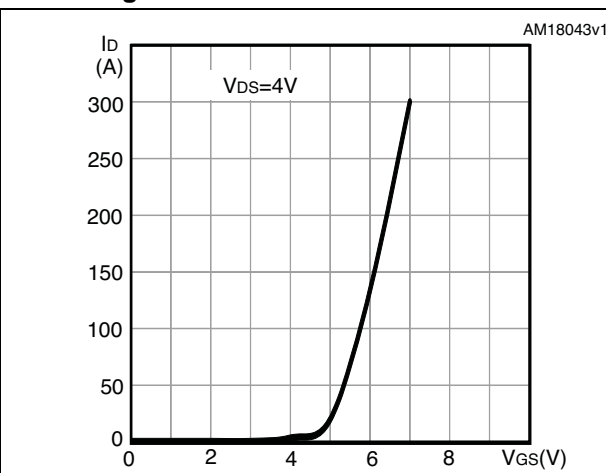

Figure 6. Gate charge vs gate-source voltage

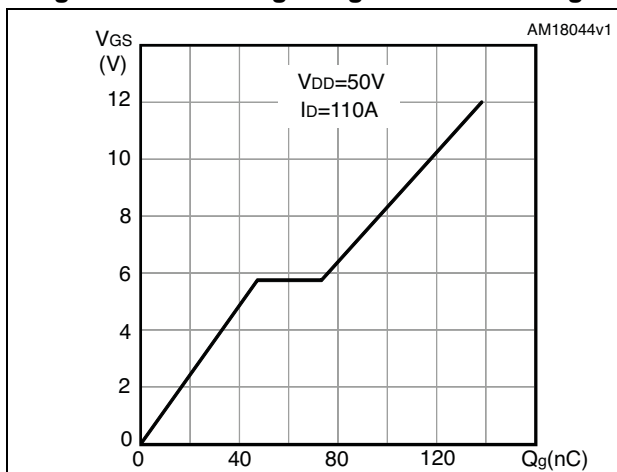

Figure 7. Static drain-source on-resistance

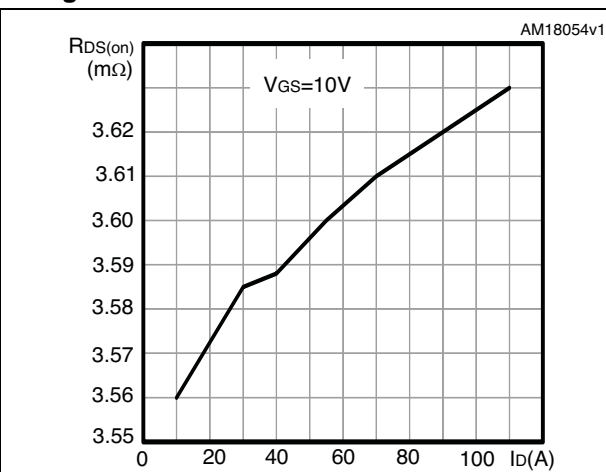

Figure 8. Capacitance variations

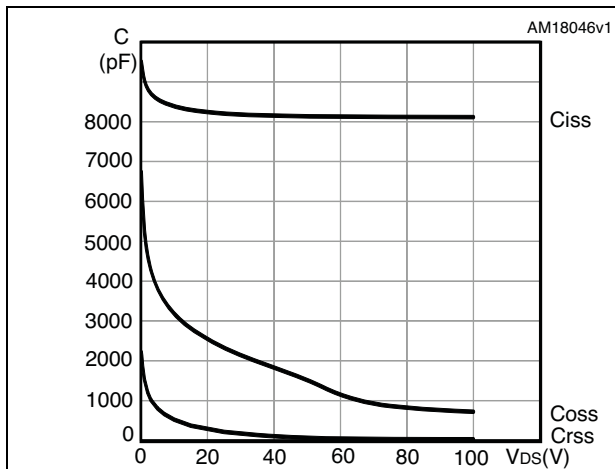

Figure 9. Normalized gate threshold voltage vs temperature

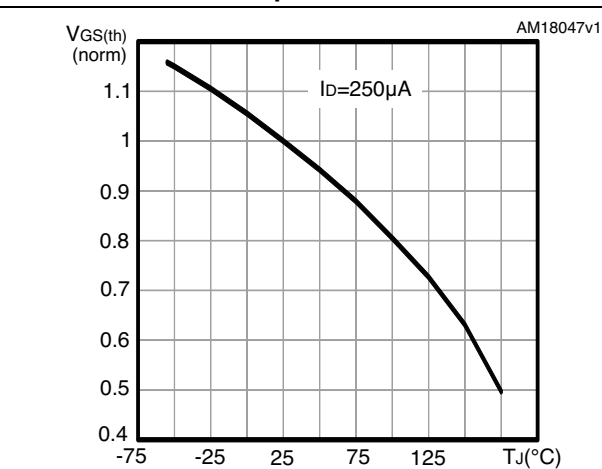

Figure 10. Normalized on-resistance vs temperature

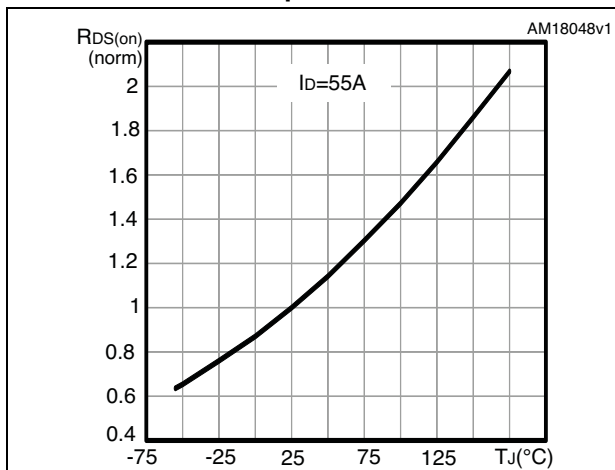

Figure 11. Normalized V_{DS} vs temperature

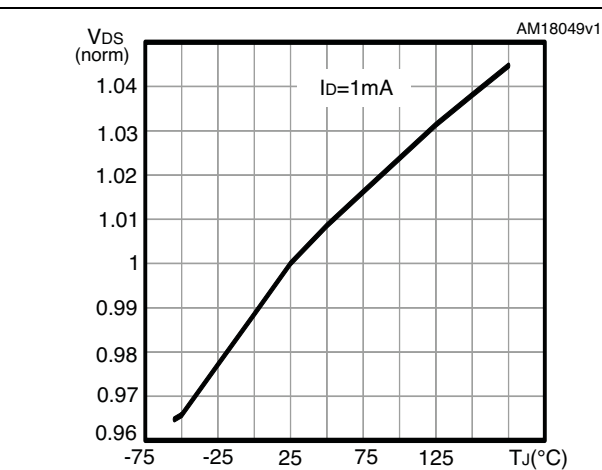
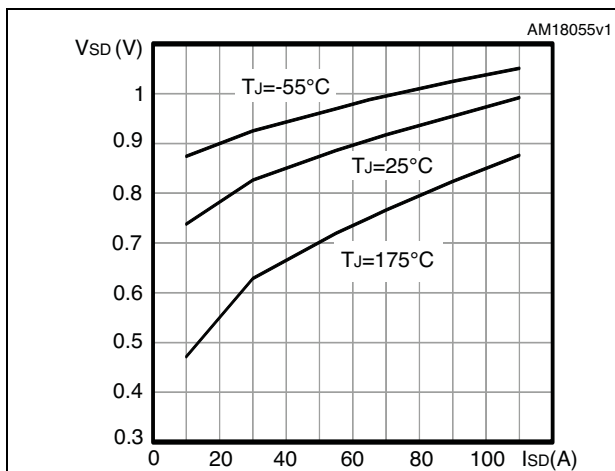

Figure 12. Source-drain diode forward characteristics



3 Test circuits

Figure 13. Switching times test circuit for resistive load



Figure 14. Gate charge test circuit



Figure 15. Test circuit for inductive load switching and diode recovery times



Figure 16. Unclamped inductive load test circuit



Figure 17. Unclamped inductive waveform



Figure 18. Switching time waveform



4 Package mechanical data

In order to meet environmental requirements, ST offers these devices in different grades of ECOPACK[®] packages, depending on their level of environmental compliance. ECOPACK[®] specifications, grade definitions and product status are available at: www.st.com. ECOPACK[®] is an ST trademark.

Figure 19. TO-220 type A drawing

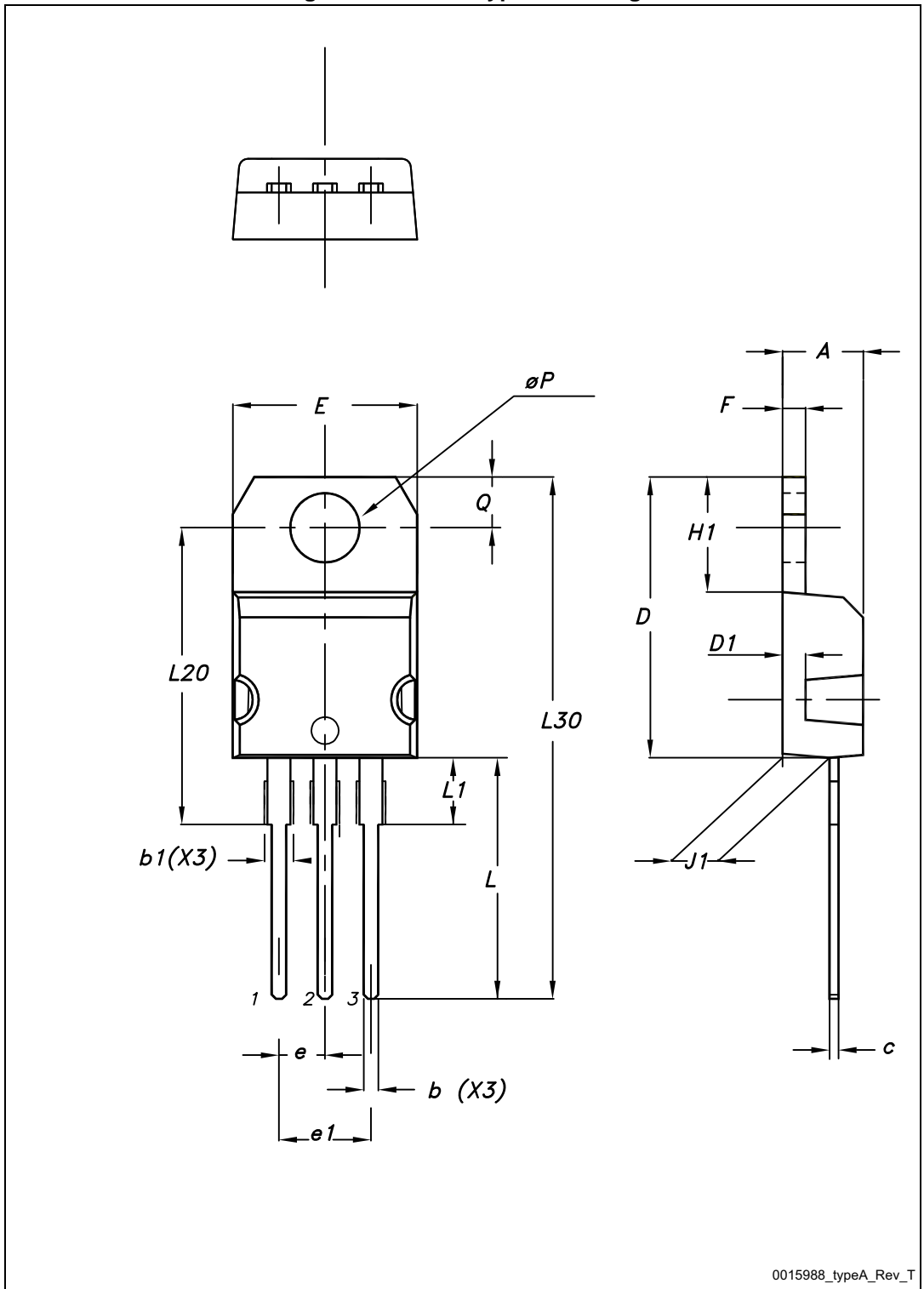

Table 8. TO-220 type A mechanical data

Dim.	mm		
	Min.	Typ.	Max.
A	4.40		4.60
b	0.61		0.88
b1	1.14		1.70
c	0.48		0.70
D	15.25		15.75
D1		1.27	
E	10		10.40
e	2.40		2.70
e1	4.95		5.15
F	1.23		1.32
H1	6.20		6.60
J1	2.40		2.72
L	13		14
L1	3.50		3.93
L20		16.40	
L30		28.90	
ØP	3.75		3.85
Q	2.65		2.95

5 Revision history

Table 9. Document revision history

Date	Revision	Changes
10-Jul-2013	1	First release.
21-Jan-2013	2	<ul style="list-style-type: none"> – The part number STH15810-2 has been moved to a separate datasheet – Modified: Figure 1 – Modified: I_D and I_{DM} values in Table 2 – Modified: $R_{thj-case}$ value in Table 3 – Modified: $R_{DS(on)}$ values in Table 4 – Modified: V_{SD}, I_D and the entire typical values in Table 5, 6 and 7 – Updated: Figure 13, 14, 15 and 16 – Updated: Section 4: Package mechanical data – Added: Section 2.1: Electrical characteristics (curves) – Minor text changes
29-Jan-2013	3	<ul style="list-style-type: none"> – Document status promoted from preliminary data to production data – Modified: title – Modified: $R_{DS(on)}$ typical value in Table 4 – Minor text changes
20-Aug-2014	4	<ul style="list-style-type: none"> Updated title in cover page. Added E_{AS} parameter in Table 2: Absolute maximum ratings.

IMPORTANT NOTICE – PLEASE READ CAREFULLY

STMicroelectronics NV and its subsidiaries (“ST”) reserve the right to make changes, corrections, enhancements, modifications, and improvements to ST products and/or to this document at any time without notice. Purchasers should obtain the latest relevant information on ST products before placing orders. ST products are sold pursuant to ST’s terms and conditions of sale in place at the time of order acknowledgement.

Purchasers are solely responsible for the choice, selection, and use of ST products and ST assumes no liability for application assistance or the design of Purchasers’ products.

No license, express or implied, to any intellectual property right is granted by ST herein.

Resale of ST products with provisions different from the information set forth herein shall void any warranty granted by ST for such product.

ST and the ST logo are trademarks of ST. All other product or service names are the property of their respective owners.

Information in this document supersedes and replaces information previously supplied in any prior versions of this document.

© 2014 STMicroelectronics – All rights reserved