

## SURFACE MOUNT RECTIFIER

### FEATURES

- High Performance & Reliability best suited for Automotive application
- Plastic package has underwrites laboratory flammability Classification 94V-0
- For surface mounted applications
- Low profile package
- Built-in strain relief, ideal for automated placement
- Glass Passivated chip junction
- High temperature soldering:  
250°C/10 second at terminals

### MECHANICAL DATA

- Case: JEDED DO-214AA molded plastic over glass passivated chip
- Terminals: Solder plated, Solderable per MIL-STD-750, method 2026
- Polarity: Color band denotes cathode end
- Weight: 0.007ounce, 0.25 gram

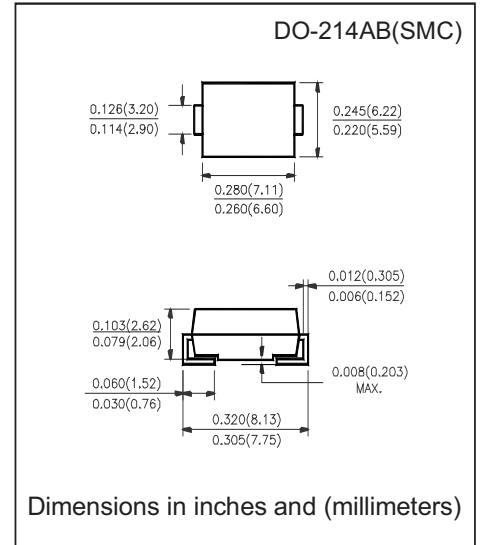

### MAXIMUM RATINGS AND ELECTRICAL CHARACTERISTICS

- Ratings at 25°C ambient temperature unless otherwise specified

PARAMETER	SYMBOLS	S3A	S3B	S3D	S3G	S3J	S3K	S3M	UNIT
Maximum Repetitive Peak Reverse Voltage	$V_{RRM}$	50	100	200	400	600	800	1000	Volts
Maximum RMS Voltage	$V_{RMS}$	35	70	140	280	420	560	700	Volts
Maximum DC Blocking Voltage	$V_{DC}$	50	100	200	400	600	800	1000	Volts
Maximum Average Forward Rectified Current at $T_L=100^\circ\text{C}$ (NOTE 3)	$I_{(AV)}$	3.0							Amps
Peak Forward Surge Current 8.3ms single half sine wave superimposed on rated load (JEDEC method) $T_L=100^\circ\text{C}$	$I_{FSM}$	100							Amps
Maximum Instantaneous Forward Voltage at 3.0A	$V_F$	1							Volts
Maximum DC Reverse Current at rated DC Blocking Voltage	$T_A = 25^\circ\text{C}$	10.0							$\mu\text{A}$
	$T_A = 125^\circ\text{C}$								
Typical Reverse Recovery Time (NOTE 1)	$T_{rr}$	2.5							$\mu\text{s}$
Typical junction capacitance (NOTE 2)	$C_J$	60							pF
Typical Thermal Resistance (NOTE 3)	$R_{\theta JL}$	47							$^\circ\text{C/W}$
	$R_{\theta JA}$	13							
Operating and Storage Temperature Range	$T_J, T_{STG}$	-55 to +150							$^\circ\text{C}$

#### Notes:

- Reverse recovery test conditions:  $I_F = 0.5\text{A}$ ,  $I_R = 1.0\text{A}$ ,  $I_{rr} = 0.25\text{A}$
- Measured at 1.0MHz and applied reverse voltage of 4.0 Volts
- Thermal resistance from Junction to ambient and from junction to lead mounted on P.C.B. with  $0.3 \times 0.3''$  ( $8.0 \times 8.0\text{mm}$ ) copper pad areas.

## SURFACE MOUNT RECTIFIER

### RATINGS AND CHARACTERISTIC CURVES S3A - S3M

F1G.1-FORWARD CURRENT DERATING CURVE

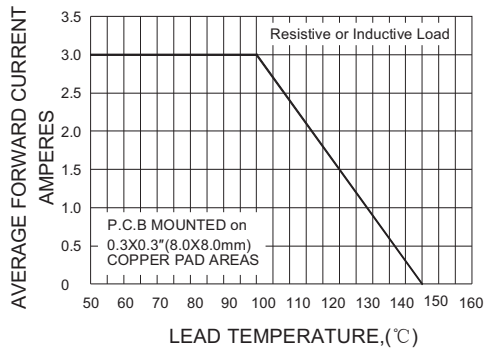

F1G.2-MAXIMUM NON-REPETITIVE PEAK FORWARD SURGE CURRENT

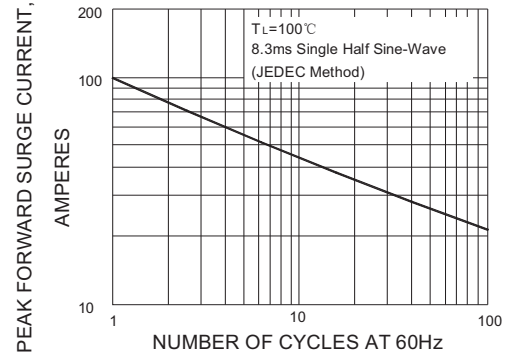

F1G.3-TYPICAL INSTANTANEOUS FORWARD CHARACTERISTICS

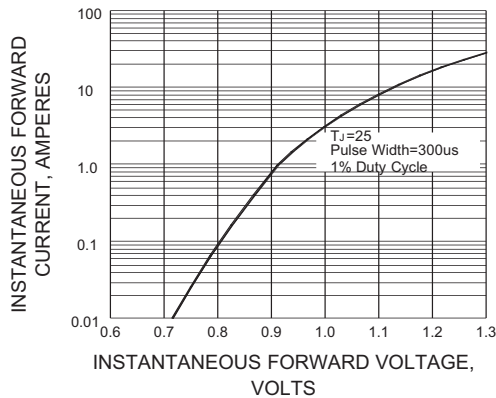

F1G.4-TYPICAL REVERSE CHARACTERISTICS

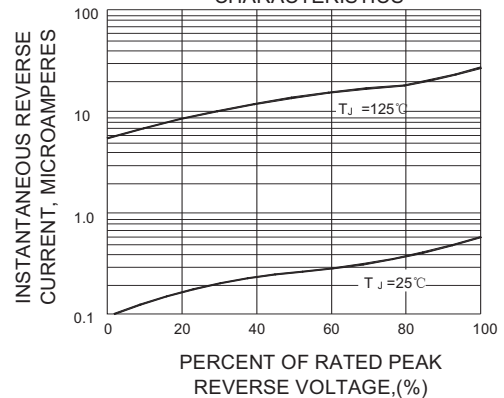

F1G.5-TYPICAL JUNCTION CAPACITANCE

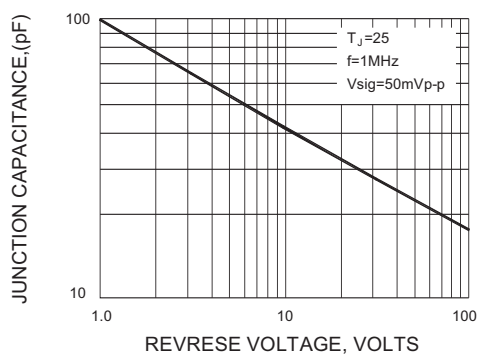

F1G.6-TYPICAL TRANSIENT THERMAL IMPEDANCE

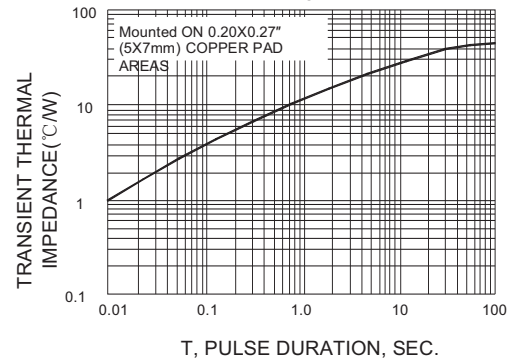

#### Disclaimer

All product, product specifications and data are subject to change without notice to improve reliability, function or design or otherwise.