

SANYO	No.1718B	LA4550
	2-CHANNEL AF POWER AMP FOR RADIO, TAPE RECORDER USE	

Features

- . Low quiescent current
- . On-chip 2 channels permitting use in stereo and bridge amplifier applications
- . High output
- . Minimum number of external parts required (9 pcs. minimum)
- . Good ripple rejection (at steady state)
- . Soft tone at the output saturation mode
- . Good channel separation
- . Easy thermal design
- . Small pop noise at the time of power supply ON/OFF

Maximum Ratings at Ta=25°C

Maximum Supply Voltage	V_{CCmax}	13	V
Allowable Power Dissipation	P_{dmax} *	4	W
Operating Temperature	T_{opr}	-20 to +75	°C
Storage Temperature	T_{stg}	-55 to +150	°C

* With recommended PCB (See sample printed circuit pattern.)

Operating Conditions at Ta=25°C

Recommended Supply Voltage	V_{CC}	6,9	V
Recommended Load Resistance	R_L	Stereo 6V	2 to 8 ohm
		BTL 6V	4 to 8 ohm
		Stereo 9V	4 to 8 ohm
		BTL 9V	8 ohm
Operating Voltage Range	V_{CCop}	3.6 to 12	V

Equivalent Circuit Block Diagram

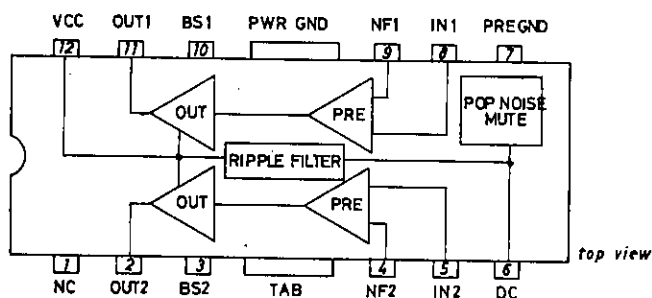

NC pin: No connection

Package Dimensions (unit: mm)
3022A

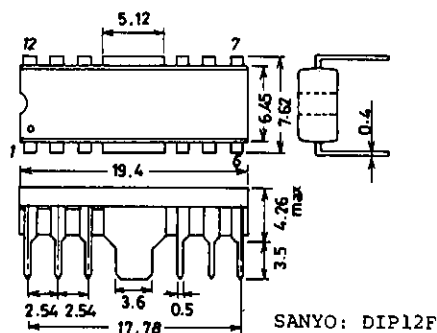

LA4550

Operating Characteristics at $T_a=25^\circ\text{C}$, $V_{CC}=9\text{V}$, $f=1\text{kHz}$, $R_g=600\text{ohms}$, $R_L=4\text{ohms}$,
 (): $R_L=8\text{ohms}$, See specified Test Circuit.

			min	typ	max	unit
Quiescent Current	Icco Stereo	9V		15	30	mA
		6V		13		mA
Voltage Gain	VG	$R_f=0, V_{IN}=-51\text{dBm}$	49	51	53	dB
Voltage Gain Difference	ΔVG	$R_f=0, V_{IN}=-51\text{dBm}$			± 1	dB
Output Power	Po	Stereo: $V_{CC}=6\text{V}, \text{THD}=10\%$	0.6	1.0		W
		BTL: $V_{CC}=6\text{V}, \text{THD}=10\%$		2.5		W
		Stereo: $V_{CC}=9\text{V}, \text{THD}=10\%$	1.6	2.1		W
		BTL: $V_{CC}=9\text{V}, \text{THD}=10\%$		(4.1)		W
Total Harmonic Distortion	THD	Po=250mW		0.3	1.5	%
Input Resistance	ri		21	30		kohm
Output Noise Voltage	V_{NO}	$R_g=0$		0.5	1.0	mV
		$R_g=10\text{kohms}$		0.8	2.0	mV
Ripple Rejection	Rr	$R_g=0, f=100\text{Hz}, V_p=150\text{mV}$	40	48		dB
Crosstalk	CT	$R_g=10\text{kohms}, f=1\text{kHz}, V_o=0\text{dBm}$	40	58		dB

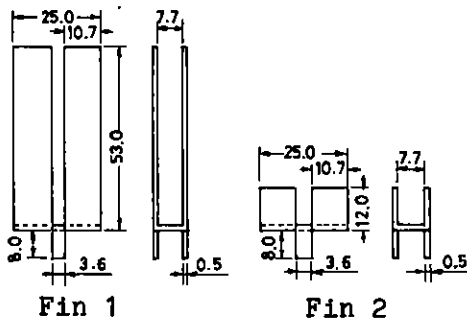
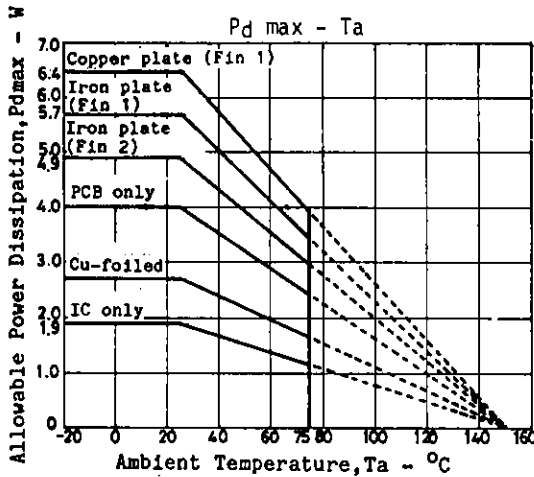

Sample Application Circuit

[Stereo Use]

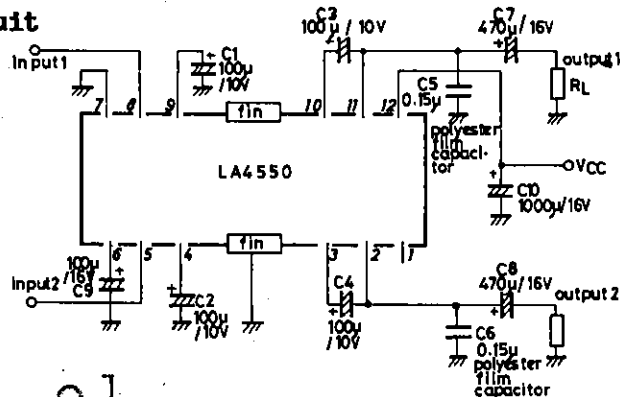

Sample Printed Circuit Pattern
 Cu foil-reduced board

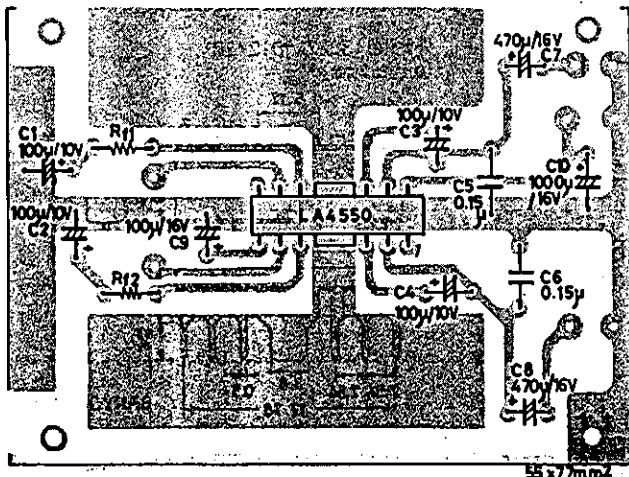

Unit (resistance: Ω , capacitance: F)

Sample Printed Circuit Pattern
 (Cu-foiled area) for Stereo Use

[BTL Use 1]

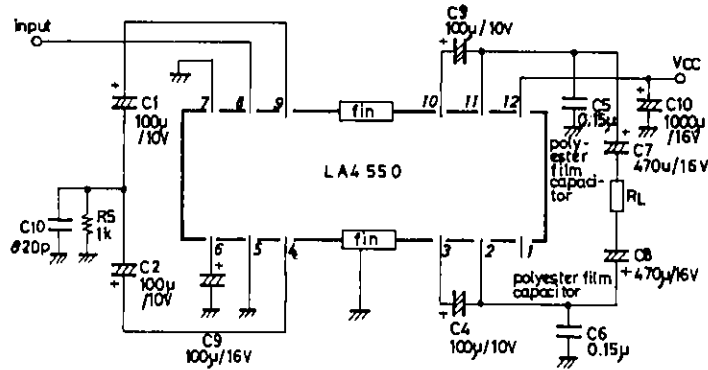

[BTL Use 2]

Unit (resistance: Ω, capacitance: F)

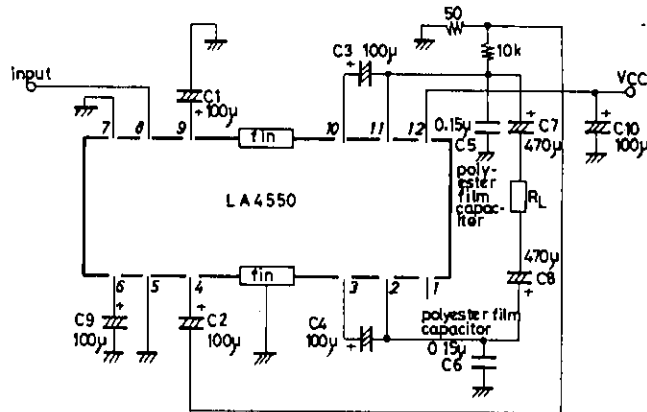

Description of External Parts

C1(C2): Feedback capacitor. The low cutoff frequency is determined by the following formula.

$$f_L = \frac{1}{2\pi C1 Rf} \quad \begin{array}{l} Rf: \text{Feedback resistor} \\ f_L: \text{Low cutoff frequency} \end{array}$$

Since this capacitor as well as decoupling capacitor affects the starting time, the capacitor value must be fixed with the necessary low frequency band fully considered.

C3(C4): Bootstrap capacitor. The output at low frequencies depends on this capacitor. Decreasing the capacitor value lowers the output at low frequencies. A capacitor value of 47µF or more is required.

C5(C6): Oscillation blocking capacitor. Use a polyester film capacitor that is good in high frequency response and temperature characteristic. The use of an electrolytic capacitor, ceramic capacitor may cause oscillation to occur at low temperatures.

C7(C8): Output capacitor. The low cutoff frequency is determined by the following formula.

$$f_L = \frac{1}{2\pi C7 RL} \quad \begin{array}{l} f_L: \text{Low cutoff frequency} \\ RL: \text{Load resistance} \end{array}$$

To make the low frequency response in the bridge amplifier mode identical with that in the stereo mode, the capacitor value must be doubled.

C9: Decoupling capacitor. Used for the ripple filter. Since the rejection effect is saturated the capacitor value more than needed. This capacitor, being also used for the time constant of the muting circuit, affects the starting time.

C10: Power source capacitor

Application Circuits

Voltage gain adjust

• Stereo mode

The voltage gain is determined by on-chip resistor R1(R2) and external feedback resistor Rf as follows:

$$VG = 20 \log \frac{R1}{Rf1 + R2} \text{ [dB]}$$

Any voltage gain can be obtained by external resistor Rf.

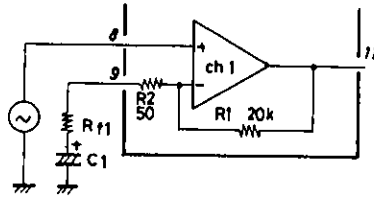

• [BTL1]

Bridge amplifier 1 mode

$$Vo1 \approx \frac{R1}{R2 + R4 + Rf1 + Rf2} Vi$$

$$Vo2 \approx - \frac{R3}{R2 + R4 + Rf1 + Rf2} Vi$$

$$Vo = Vo1 - Vo2 = \frac{R1 + R3}{R2 + R4 + Rf1 + Rf2} Vi$$

$$\therefore VG = 20 \log \frac{Vo}{Vi} = 20 \log \frac{R1 + R3}{R2 + R4 + Rf1 + Rf2} \text{ [dB]}$$

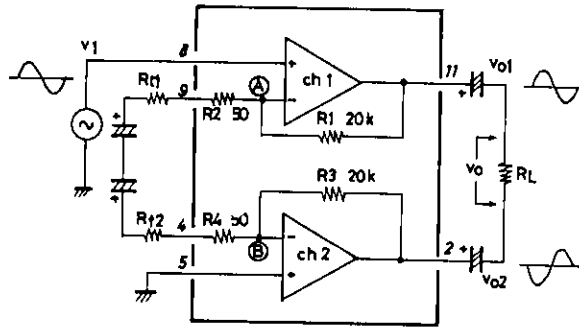

Assuming R2=R4=50ohms, R1=R3=20kohms and Rf1=Rf2, the voltage gain is obtained by:

$$VG = 20 \log \frac{R1}{Rf1 + R2} \text{ [dB]}$$

[BTL2]

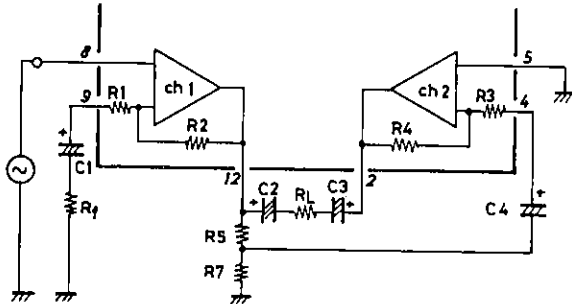

Bridge amplifier 2 mode

The CH1 is a noninverting amplifier and the CH2 is an inverting amplifier. The total voltage gain, being apparently higher than that of the CH1 by 6dB, is approximately calculated by the following formula.

$$VG = 20 \log \frac{R2}{R1 + 6} \text{ (dB)}$$

To reduce the voltage gain, Rf is connected and the following formula is used.

$$VG = 20 \log \frac{R2}{Rf + R1 + 6} \text{ (dB)}$$

Proper Cares in Using LA4550-applied Set

1. If the transformer regulation is not as specified, the supply voltage drops momentarily when the motor of an AC-powered set is turned ON. In this case, hum noise may be generated. So, be careful of the transformer regulation.
2. DC muting

To apply DC muting by controlling the NF pin, it is recommended to use the circuit configuration shown right. The potential at point (A) is set to 3.5 to 4V.

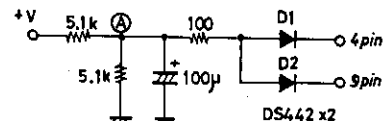

3. Pop noise

If pop noise generated at the time of power ON/OFF disturbs you, connect a resistor of approximately 620ohms across the middle point and GND.

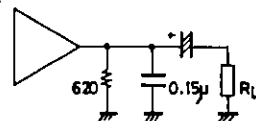

4. Slider contact noise of variable resistor

Since the input circuit uses PNP transistors, no input coupling capacitor is required. However, if slider contact noise of the variable resistor presents any problem, connect a capacitor in series with input.

Thermal Design

Since the DIP-12F package is such that the Cu-foiled area of the printed circuit board is used to dissipate heat, make the Cu-foiled area in the vicinity of the heat sink of the IC as large as possible when designing the printed circuit board. The use of the Cu-foiled area indicated by shading in the above-mentioned sample printed circuit pattern makes it possible to dissipate more heat. Power dissipation Pd is increased depending on the supply voltage and load. So, it is recommended to use the printed circuit board together with the heat sink. The following is a formula to be used to calculate Pd (for stereo use). For AC power supply, however, it is recommended to actually measure Pd on the transformer of each set. For bridge amplifier use, Pd is calculated at 1/2 of the load.

(1) DC power supply

$$P_d \max = \frac{V_{CC}^2}{\pi^2 R_L} + I_{CCO} \cdot V_{CC} \quad \text{(For stereo use).....(1)}$$

(2) AC power supply

- V_{CC2} : Supply voltage at quiescent mode
- V_{CC(Pd)}: Supply voltage at Pd max
- V_{CC1} : Supply voltage at maximum output
- r : Voltage regulation $\frac{V_{CC2} - V_{CC1}}{V_{CC1}}$

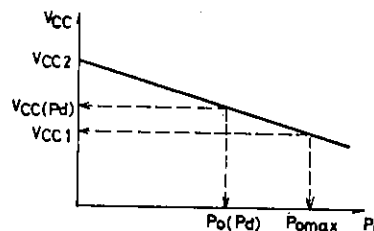

I_{CCO} : Quiescent current

Supply voltage regulation

$$P_d \max = \frac{V_{CC(Pd)}^2}{\pi^2 R_L} + I_{CCO} \cdot V_{CC(Pd)} \quad \text{(For stereo use).....(2)}$$

where

$$V_{CC(Pd)} = \frac{(1+r)V_{CC1}}{1 + \frac{r \cdot V_{CC1}}{\sqrt{2} \cdot \pi \cdot R_L} \times \sqrt{\frac{R_L}{P_o \max}}}$$

Example of Heat Sink Mounting Method

The heat sink must be of such a shape as to be able to dissipate heat from the IC plastic area and fin area and is soldered to the printed circuit board as shown below. For the size of the heat sink, refer to the Pd-Ta characteristic. The material of the heat sink is recommended to be copper or iron which is solderable. It is recommended to apply silicone grease to the IC plastic area to reduce thermal resistance between the heat sink and the IC plastic area.

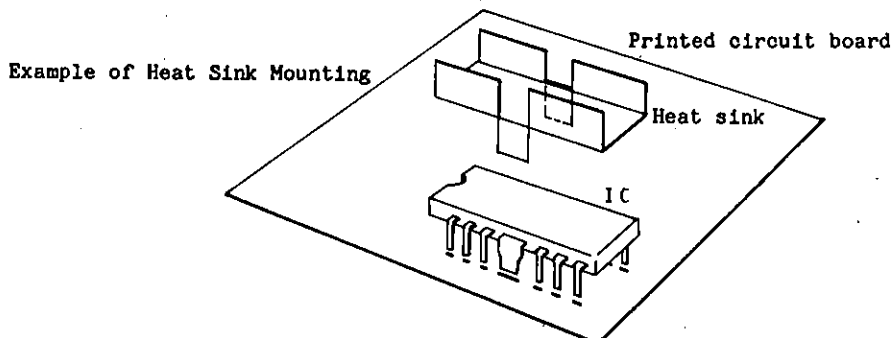

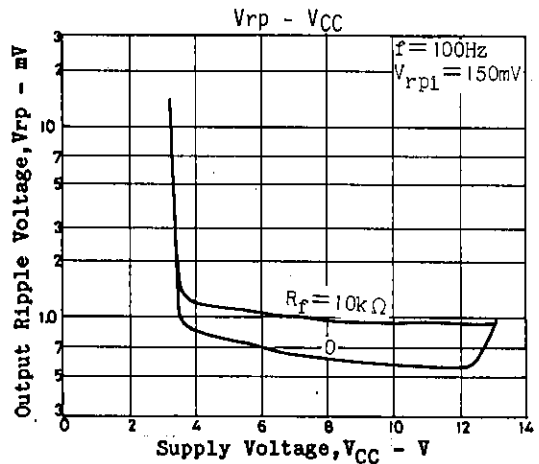
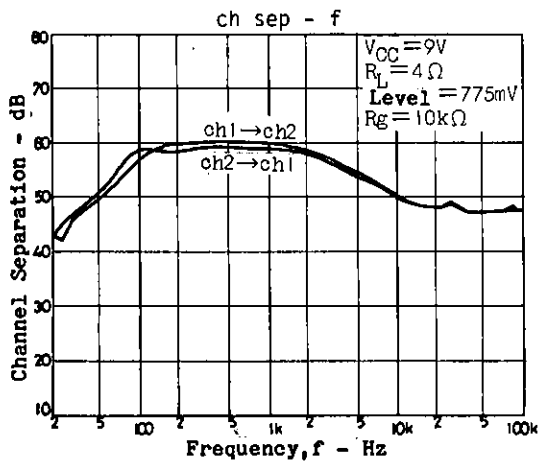
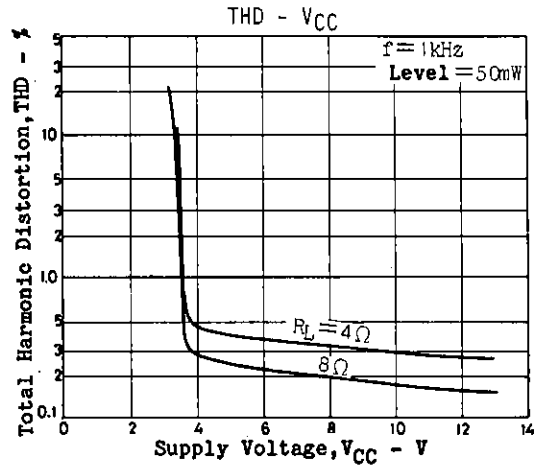
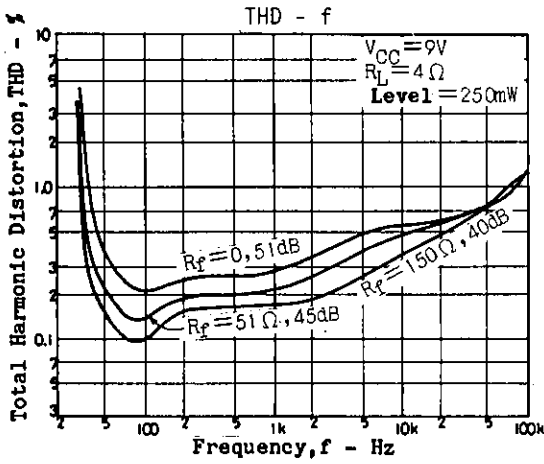
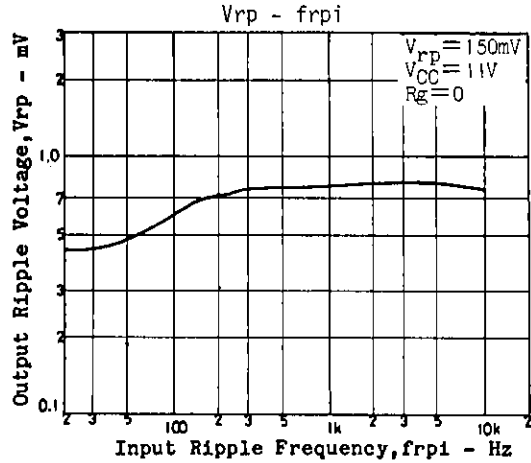
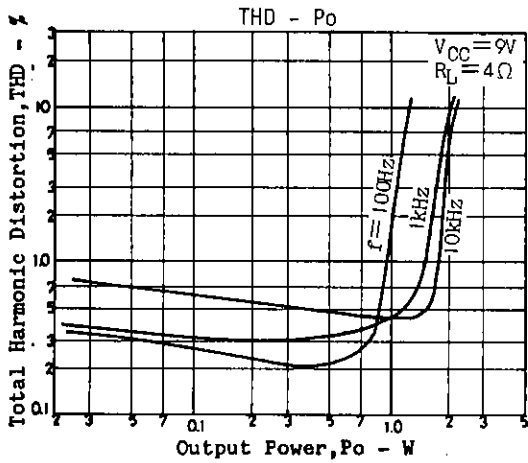
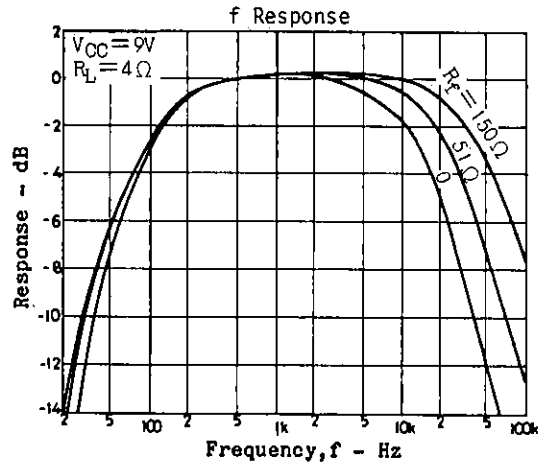
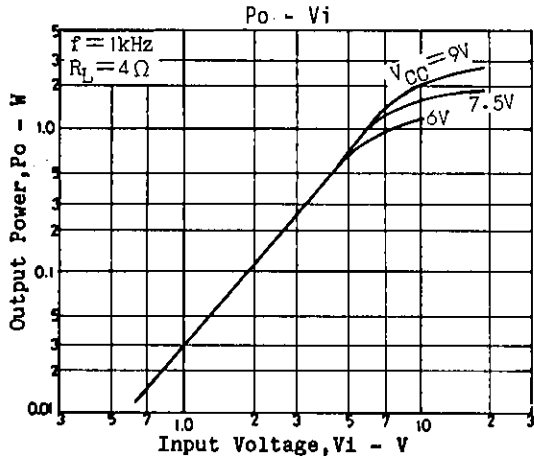

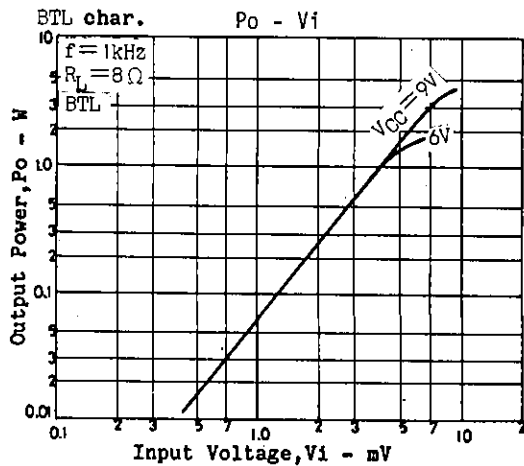
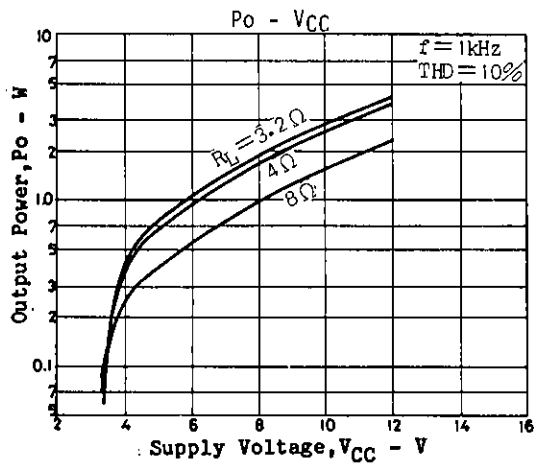
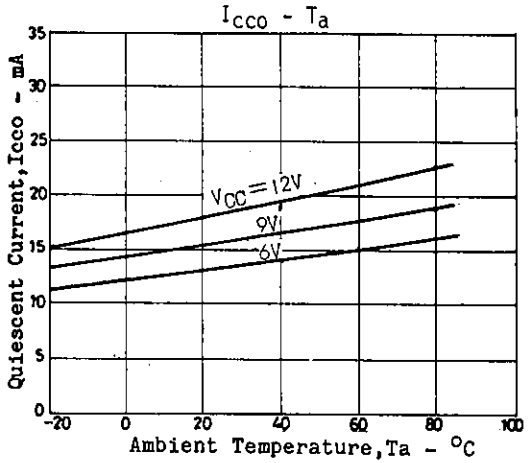
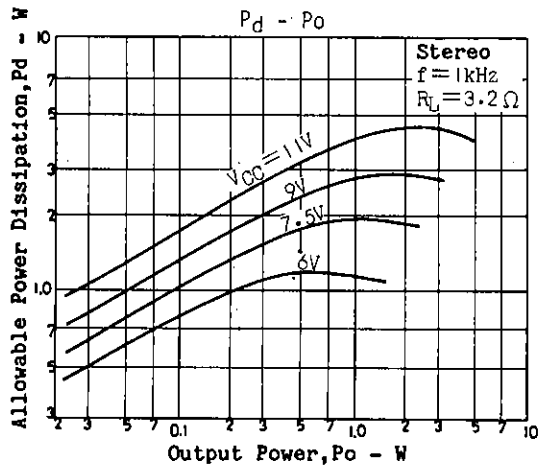
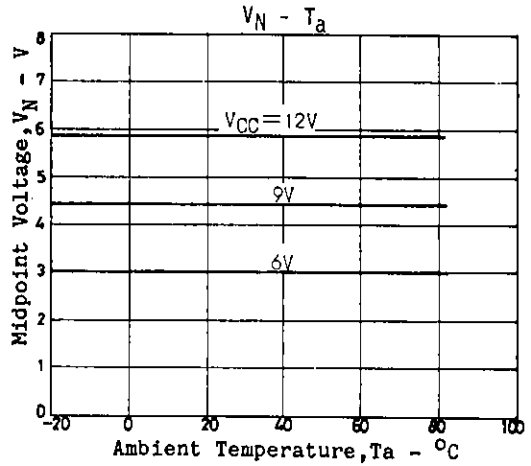
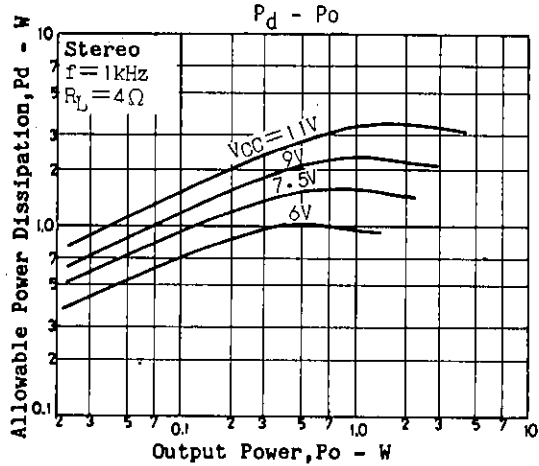
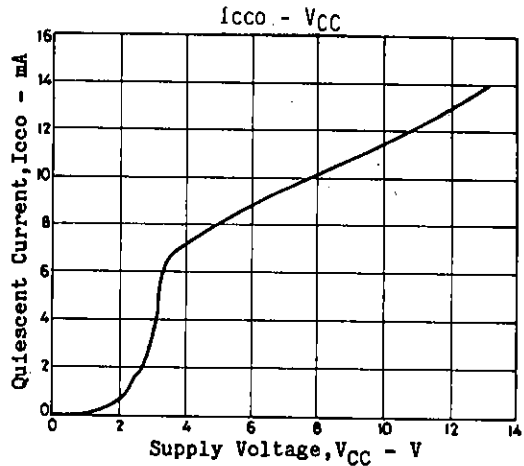
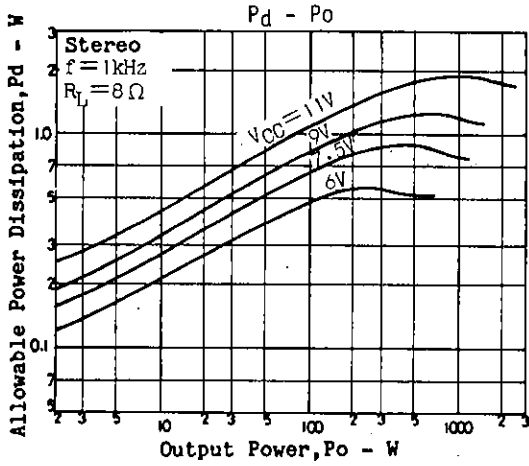

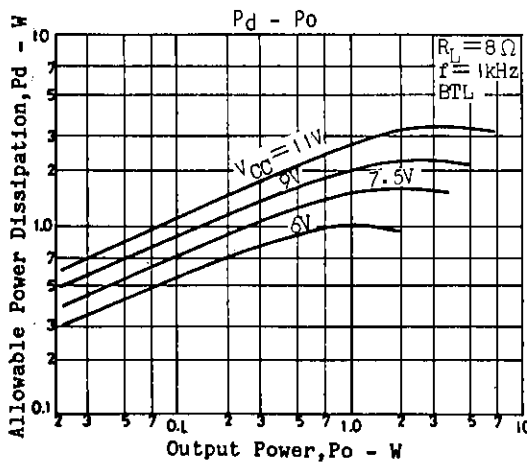
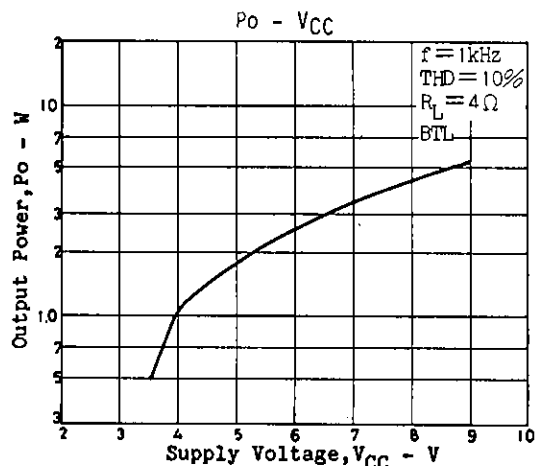
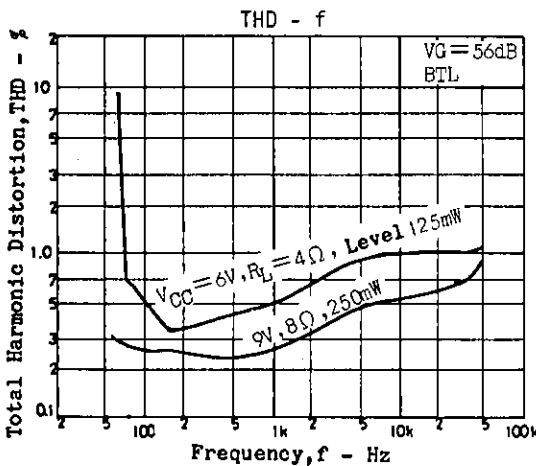
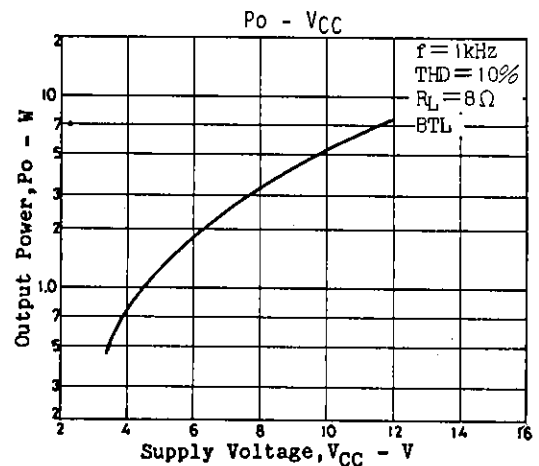
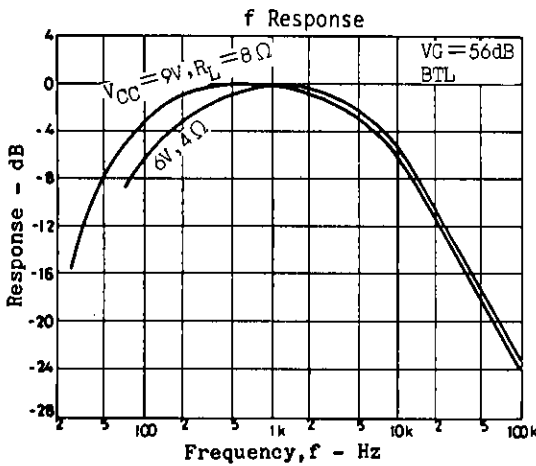
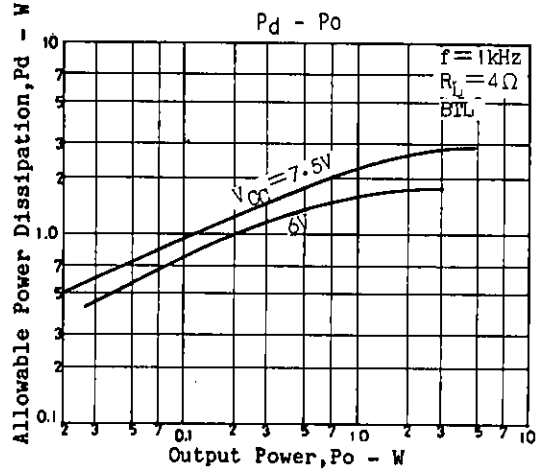
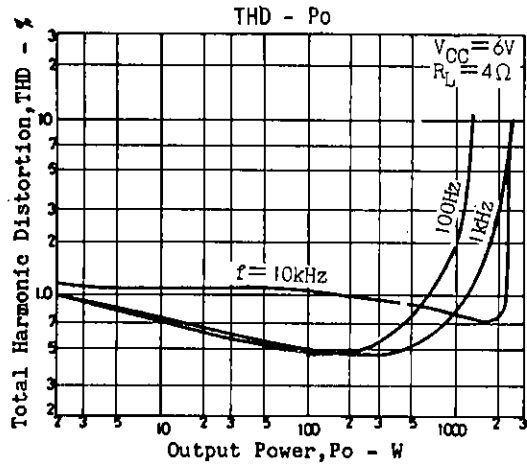

Proper Cares in Using IC

1. If the IC is used in the vicinity of the maximum ratings, even a slight variation in conditions may cause the maximum ratings to be exceeded, thereby leading to breakdown. Allow an ample margin of variation for supply voltage, etc. and use the IC in the range where the maximum ratings are not exceeded.
2. Pin-to-pin short
If power is applied when the space between pins is shorted, breakdown or deterioration may occur. When mounting the IC on the board or applying power, make sure that the space between pins is not shorted with solder, etc.
3. Load short
If the IC is used with the load shorted for a long time, breakdown or deterioration may occur. Be sure not to short the load.
4. When the IC is used in radios or radio cassette tape recorders, keep a good distance between IC and bar antenna.
5. When making the board, refer to the sample printed circuit pattern.
6. It should be noted that some plug jacks to be used for connecting to the external speaker are such that both poles are shorted once when connecting.

- No products described or contained herein are intended for use in surgical implants, life-support systems, aerospace equipment, nuclear power control systems, vehicles, disaster/crime-prevention equipment and the like, the failure of which may directly or indirectly cause injury, death or property loss.
- Anyone purchasing any products described or contained herein for an above-mentioned use shall:
 - ① Accept full responsibility and indemnify and defend SANYO ELECTRIC CO., LTD., its affiliates, subsidiaries and distributors and all their officers and employees, jointly and severally, against any and all claims and litigation and all damages, cost and expenses associated with such use:
 - ② Not impose any responsibility for any fault or negligence which may be cited in any such claim or litigation on SANYO ELECTRIC CO., LTD., its affiliates, subsidiaries and distributors or any of their officers and employees jointly or severally.
- Information (including circuit diagrams and circuit parameters) herein is for example only; it is not guaranteed for volume production. SANYO believes information herein is accurate and reliable, but no guarantees are made or implied regarding its use or any infringements of intellectual property rights or other rights of third parties.