

### Features

1. Current transfer ratio  
(CTR:MIN.60% at  $I_F = \pm 1\text{mA}$   $V_{ce} = 5\text{V}$ )
2. High isolation voltage between input and output  
(Viso:5000Vrms).
3. Compact dual-in-line package.
4. Ac input.
5. Available package : DIP/ SMD/ H. (For Package Dimension please refer to page 83 )

### Applications

1. Programmable Controller Applications for Low Input Photocouplers and High  $V_{ceo}$  Photocouplers.
2. Telephone sets, telephone exchangers.
3. System appliances, Limit Switches , Sensors, Thermostats , Transducers etc.
4. Signal transmission between circuits of different potentials and impedances.

### Outside Dimension : Unit (mm)

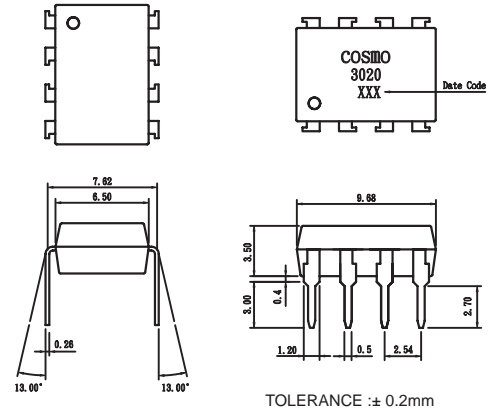

### Schematic : Top View

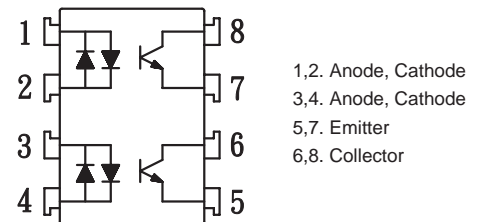

### Absolute Maximum Ratings

( $T_a = 25^\circ\text{C}$ )

Parameter		Symbol	Rating	Unit
Input	Forward current	$I_F$	$\pm 50$	mA
	Peak forward current	$I_{FM}$	$\pm 1$	A
	Power dissipation	$P_D$	70	mW
Output	Collector-emitter voltage	$V_{CEO}$	60	V
	Emitter-collector voltage	$V_{ECO}$	6	V
	Collector current	$I_C$	50	mA
	Collector power dissipation	$P_C$	150	mW
Total power dissipation		$P_{tot}$	200	mW
Isolation voltage 1 minute		Viso	5000	Vrms
Operating temperature		$T_{opr}$	-30 to +100	$^\circ\text{C}$
Storage temperature		$T_{stg}$	-55 to +125	$^\circ\text{C}$
Soldering temperature 10 second		$T_{sol}$	260	$^\circ\text{C}$

### Electro-optical Characteristics

( $T_a = 25^\circ\text{C}$ )

Parameter		Symbol	Conditions	MIN.	TYP.	MAX.	Unit
Input	Forward voltage	$V_F$	$I_F = \pm 20\text{mA}$	—	1.2	1.4	V
	Peak forward voltage	$V_{FM}$	$I_{FM} = \pm 0.5\text{A}$	—	—	3.5	V
	Terminal capacitance	$C_t$	$V = 0, f = 1\text{kHz}$	—	30	—	pF
Output	Collector dark current	$I_{CEO}$	$V_{CE} = 20\text{V}, I_F = 0$	—	—	0.1	$\mu\text{A}$
Transfer characteristics	Current transfer ratio	CTR	$I_F = \pm 1\text{mA}, V_{CE} = 5\text{V}$	60	—	600	%
	Collector-emitter saturation voltage	$V_{CE(sat)}$	$I_F = \pm 20\text{mA}, I_C = 1\text{mA}$	—	0.1	0.3	V
	Isolation resistance	Riso	DC500V	$5 \times 10^{10}$	$10^{11}$	—	ohm
	Floating capacitance	$C_f$	$V = 0, f = 1\text{MHz}$	—	0.6	1.0	pF
	Cut-off frequency	$f_c$	$V_{CC} = 5\text{V}, I_C = 2\text{mA}, R_L = 100\text{ohm}$	—	80	—	kHz
	Response time (Rise)	$t_r$	$V_{CE} = 2\text{V}, I_C = 2\text{mA}, R_L = 100\text{ohm}$	—	5	20	$\mu\text{s}$
	Response time (Fall)	$t_f$		—	4	20	$\mu\text{s}$

**Fig.1** Current Transfer Ratio vs. Forward Current

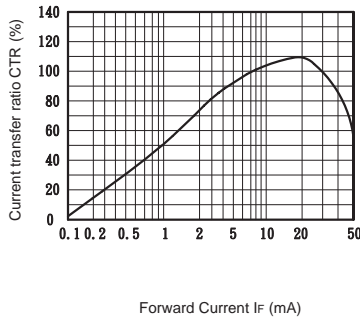

**Fig.2** Collector Power Dissipation vs. Ambient Temperature

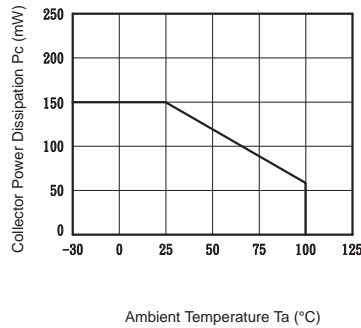

**Fig.3** Collector Dark Current vs. Ambient Temperature

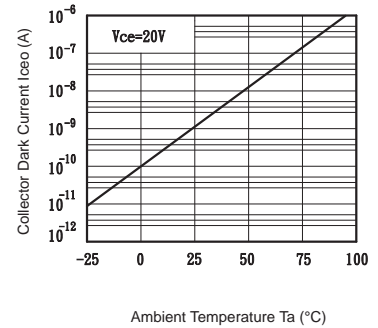

**Fig.4** Forward Current vs. Ambient Temperature

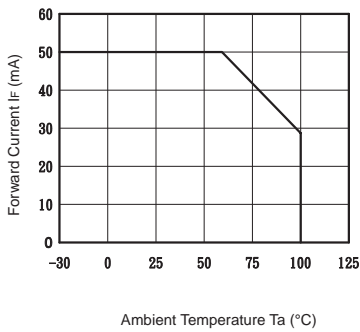

**Fig.5** Forward Current vs. Forward Voltage

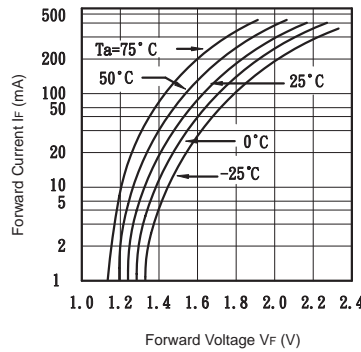

**Fig.6** Collector Current vs. Collector-emitter Voltage

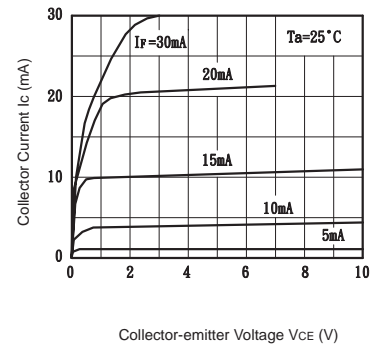

**Fig.7** Relative Current Transfer Ratio vs. Ambient Temperature

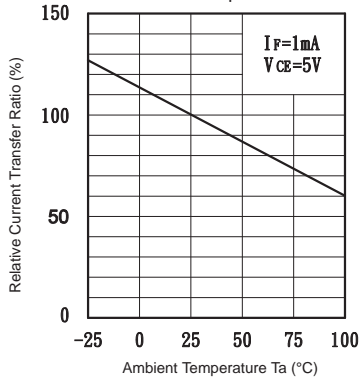

**Fig.8** Collector-emitter Saturation Voltage vs. Ambient Temperature

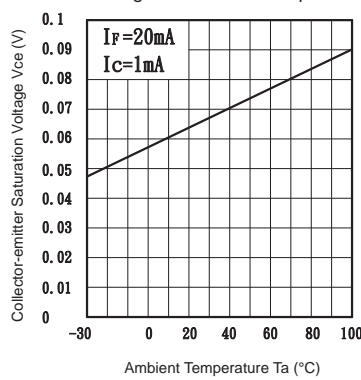

**Fig.9** Collector-emitter Saturation Voltage vs. Forward Current

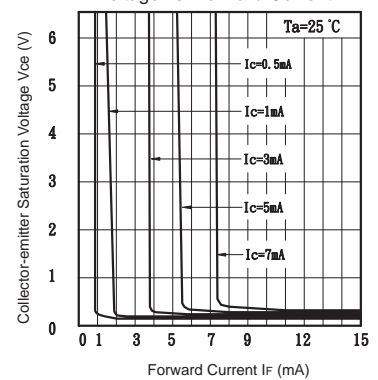

**Fig.10** Response Time vs. Load Resistance

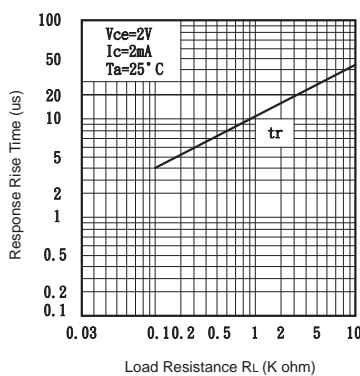

**Fig.11** Response Time vs. Load Resistance

