

IRFI4020H-117P

Features

- Integrated half-bridge package
- Reduces the part count by half
- Facilitates better PCB layout
- Key parameters optimized for Class-D audio amplifier applications
- Low $R_{DS(ON)}$ for improved efficiency
- Low Q_g and Q_{sw} for better THD and improved efficiency
- Low Q_{rr} for better THD and lower EMI
- Can delivery up to 300W per channel into 8Ω load in half-bridge configuration amplifier
- Lead-free package

| Key Parameters ⑤ | | |
|-------------------------|-----|----|
| V_{DS} | 200 | V |
| $R_{DS(ON)}$ typ. @ 10V | 80 | mΩ |
| Q_g typ. | 19 | nC |
| Q_{sw} typ. | 6.8 | nC |
| $R_{G(int)}$ typ. | 3.0 | Ω |
| T_J max | 150 | °C |

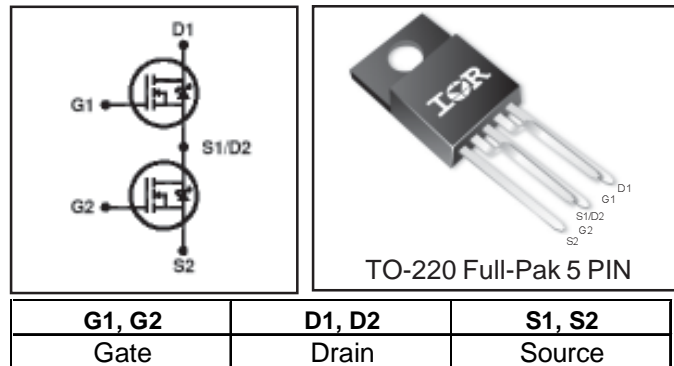

Description

This Digital Audio MosFET Half-Bridge is specifically designed for Class D audio amplifier applications. It consists of two power MosFET switches connected in half-bridge configuration. The latest process is used to achieve low on-resistance per silicon area. Furthermore, Gate charge, body-diode reverse recovery, and internal Gate resistance are optimized to improve key Class D audio amplifier performance factors such as efficiency, THD and EMI. These combine to make this Half-Bridge a highly efficient, robust and reliable device for Class D audio amplifier applications.

Absolute Maximum Ratings ⑤

| | Parameter | Max. | Units |
|-----------------------------------|--|------------------|-------|
| V_{DS} | Drain-to-Source Voltage | 200 | V |
| V_{GS} | Gate-to-Source Voltage | ±20 | |
| I_D @ $T_C = 25^\circ\text{C}$ | Continuous Drain Current, V_{GS} @ 10V | 9.1 | A |
| I_D @ $T_C = 100^\circ\text{C}$ | Continuous Drain Current, V_{GS} @ 10V | 5.7 | |
| I_{DM} | Pulsed Drain Current ① | 36 | |
| P_D @ $T_C = 25^\circ\text{C}$ | Power Dissipation ④ | 21 | W |
| P_D @ $T_C = 100^\circ\text{C}$ | Power Dissipation ④ | 8.5 | |
| | Linear Derating Factor | 0.17 | W/°C |
| E_{AS} | Single Pulse Avalanche Energy② | 130 | mJ |
| T_J | Operating Junction and | -55 to + 150 | °C |
| T_{STG} | Storage Temperature Range | | |
| | Soldering Temperature, for 10 seconds (1.6mm from case) | 300 | |
| | Mounting torque, 6-32 or M3 screw | 10lb·in (1.1N·m) | |

Thermal Resistance ⑤

| | Parameter | Typ. | Max. | Units |
|-----------------|--------------------------------|------|------|-------|
| $R_{\theta JC}$ | Junction-to-Case ④ | — | 5.9 | °C/W |
| $R_{\theta JA}$ | Junction-to-Ambient (free air) | — | 65 | |

Electrical Characteristics @ $T_J = 25^\circ\text{C}$ (unless otherwise specified) ⑤

| | Parameter | Min. | Typ. | Max. | Units | Conditions |
|--------------------------------|--------------------------------------|------|------|------|-------|---|
| BV_{DSS} | Drain-to-Source Breakdown Voltage | 200 | — | — | V | $V_{GS} = 0V, I_D = 250\mu A$ |
| $\Delta BV_{DSS}/\Delta T_J$ | Breakdown Voltage Temp. Coefficient | — | 24 | — | mV/°C | Reference to $25^\circ\text{C}, I_D = 1mA$ |
| $R_{DS(on)}$ | Static Drain-to-Source On-Resistance | — | 80 | 100 | mΩ | $V_{GS} = 10V, I_D = 5.5A$ ③ |
| $V_{GS(th)}$ | Gate Threshold Voltage | 3.0 | — | 4.9 | V | $V_{DS} = V_{GS}, I_D = 100\mu A$ |
| $\Delta V_{GS(th)}/\Delta T_J$ | Gate Threshold Voltage Coefficient | — | -12 | — | mV/°C | |
| I_{DSS} | Drain-to-Source Leakage Current | — | — | 20 | μA | $V_{DS} = 200V, V_{GS} = 0V$ |
| | | — | — | 250 | | $V_{DS} = 200V, V_{GS} = 0V, T_J = 125^\circ\text{C}$ |
| I_{GSS} | Gate-to-Source Forward Leakage | — | — | 100 | nA | $V_{GS} = 20V$ |
| | Gate-to-Source Reverse Leakage | — | — | -100 | | $V_{GS} = -20V$ |
| g_{fs} | Forward Transconductance | 11 | — | — | S | $V_{DS} = 50V, I_D = 5.5A$ |
| Q_g | Total Gate Charge | — | 19 | 29 | nC | $V_{DS} = 100V$ $V_{GS} = 10V$ $I_D = 5.5A$ See Fig. 6 and 15 |
| Q_{gs1} | Pre-Vth Gate-to-Source Charge | — | 4.9 | — | | |
| Q_{gs2} | Post-Vth Gate-to-Source Charge | — | 0.95 | — | | |
| Q_{gd} | Gate-to-Drain Charge | — | 5.8 | — | | |
| Q_{godr} | Gate Charge Overdrive | — | 7.4 | — | | |
| Q_{sw} | Switch Charge ($Q_{gs2} + Q_{gd}$) | — | 6.8 | — | | |
| $R_{G(int)}$ | Internal Gate Resistance | — | 3.0 | — | Ω | |
| $t_{d(on)}$ | Turn-On Delay Time | — | 8.4 | — | ns | $V_{DD} = 100V, V_{GS} = 10V$ ③ $I_D = 5.5A$ $R_G = 2.4\Omega$ |
| t_r | Rise Time | — | 8.0 | — | | |
| $t_{d(off)}$ | Turn-Off Delay Time | — | 18 | — | | |
| t_f | Fall Time | — | 4.0 | — | | |
| C_{iss} | Input Capacitance | — | 1240 | — | pF | $V_{GS} = 0V$ $V_{DS} = 25V$ $f = 1.0MHz,$ See Fig. 5 $V_{GS} = 0V, V_{DS} = 0V$ to $160V$ |
| C_{oss} | Output Capacitance | — | 130 | — | | |
| C_{riss} | Reverse Transfer Capacitance | — | 28 | — | | |
| $C_{oss\ eff.}$ | Effective Output Capacitance | — | 110 | — | | |
| L_D | Internal Drain Inductance | — | 4.5 | — | nH | Between lead, 6mm (0.25in.) from package and center of die contact |
| L_S | Internal Source Inductance | — | 7.5 | — | | |

Diode Characteristics ⑤

| | Parameter | Min. | Typ. | Max. | Units | Conditions |
|--------------------------------|---|------|------|------|-------|---|
| $I_S @ T_C = 25^\circ\text{C}$ | Continuous Source Current (Body Diode) | — | — | 9.1 | A | MOSFET symbol showing the integral reverse p-n junction diode. |
| I_{SM} | Pulsed Source Current (Body Diode) ① | — | — | 36 | | |
| V_{SD} | Diode Forward Voltage | — | — | 1.3 | V | $T_J = 25^\circ\text{C}, I_S = 5.5A, V_{GS} = 0V$ ③ |
| t_{rr} | Reverse Recovery Time | — | 76 | 110 | ns | $T_J = 25^\circ\text{C}, I_F = 5.5A, V_{DD} = 160V$ |
| Q_{rr} | Reverse Recovery Charge | — | 230 | 350 | nC | $di/dt = 100A/\mu s$ ③ |

Notes:

- ① Repetitive rating; pulse width limited by max. junction temperature.
- ② Starting $T_J = 25^\circ\text{C}$, $L = 8.6mH$, $R_G = 25\Omega$, $I_{AS} = 5.5A$.
- ③ Pulse width $\leq 400\mu s$; duty cycle $\leq 2\%$.
- ④ R_{θ} is measured at T_J of approximately 90°C .
- ⑤ Specifications refer to single MosFET.

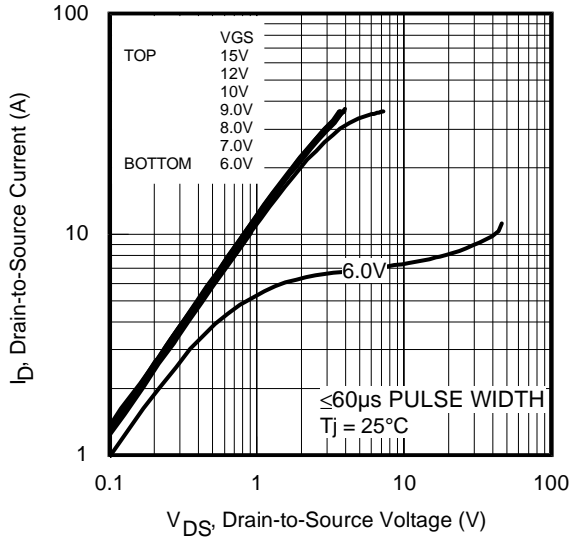

Fig 1. Typical Output Characteristics

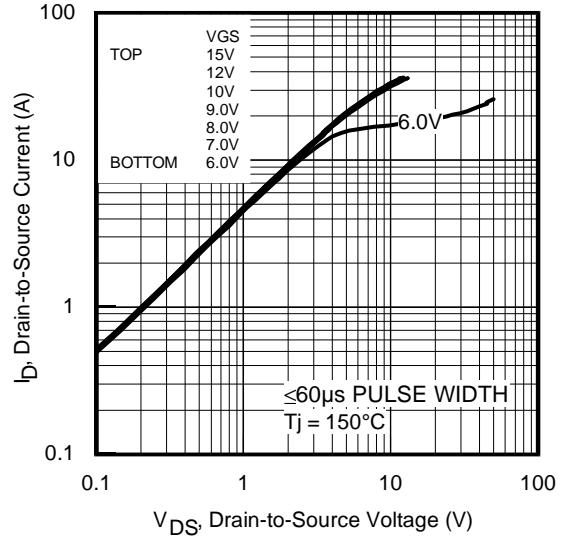

Fig 2. Typical Output Characteristics

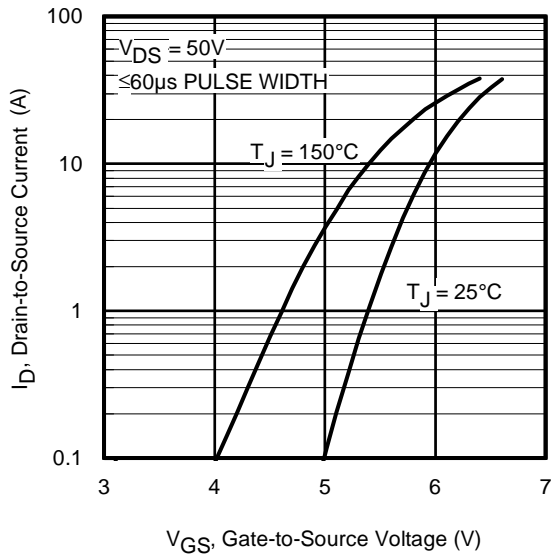

Fig 3. Typical Transfer Characteristics

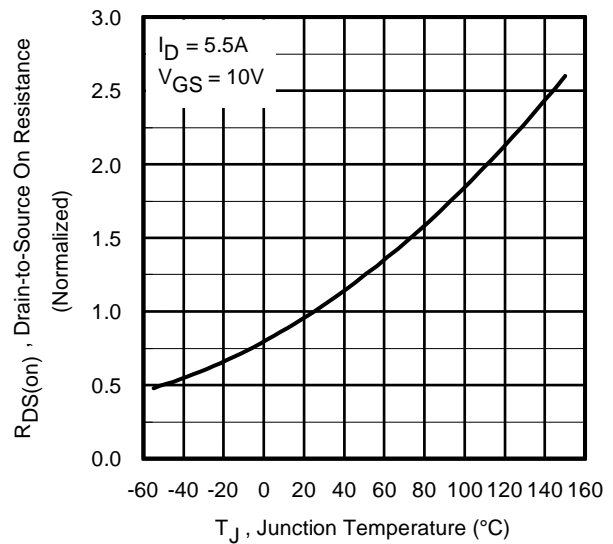

Fig 4. Normalized On-Resistance vs. Temperature

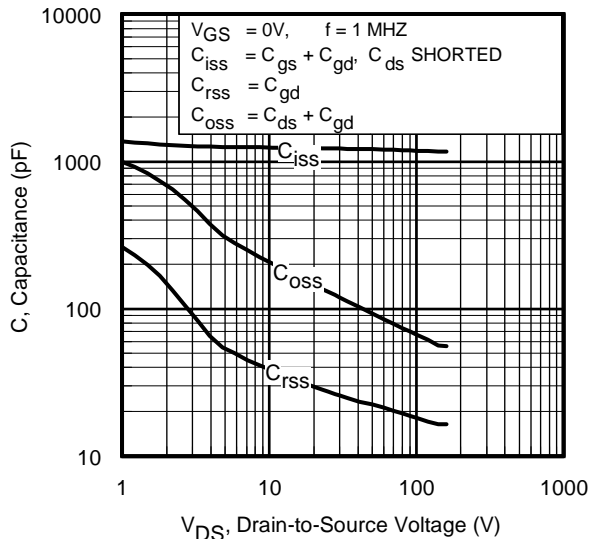

Fig 5. Typical Capacitance vs. Drain-to-Source Voltage
www.irf.com

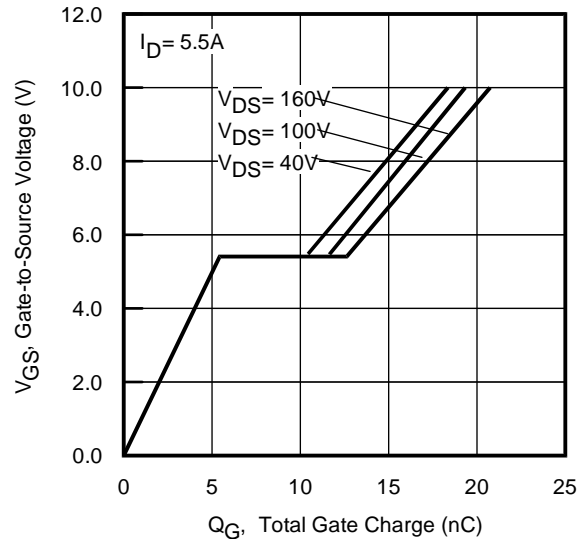

Fig 6. Typical Gate Charge vs. Gate-to-Source Voltage

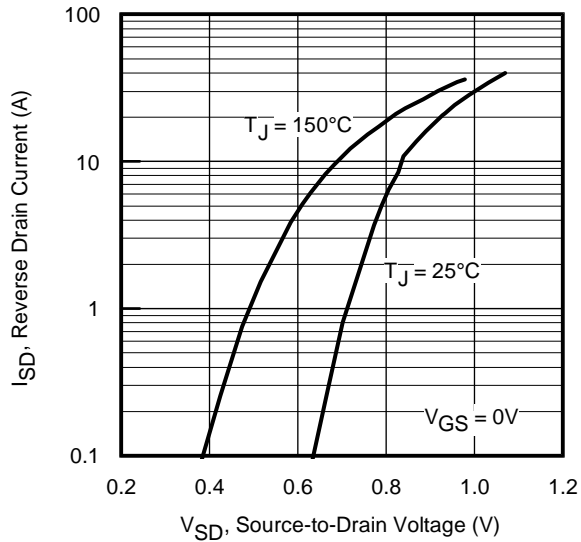

Fig 7. Typical Source-Drain Diode Forward Voltage

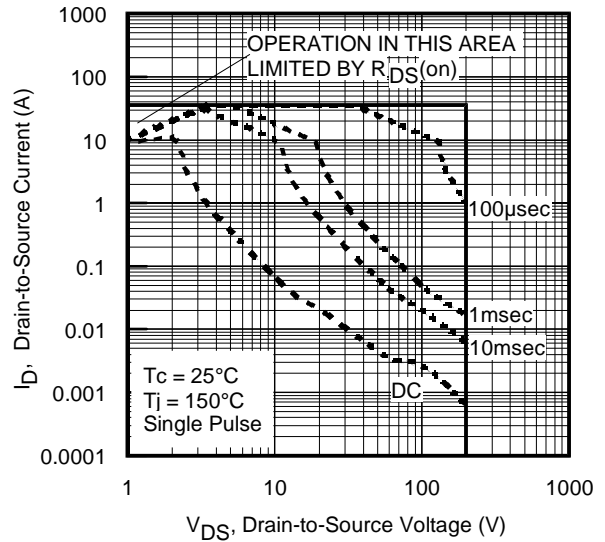

Fig 8. Maximum Safe Operating Area

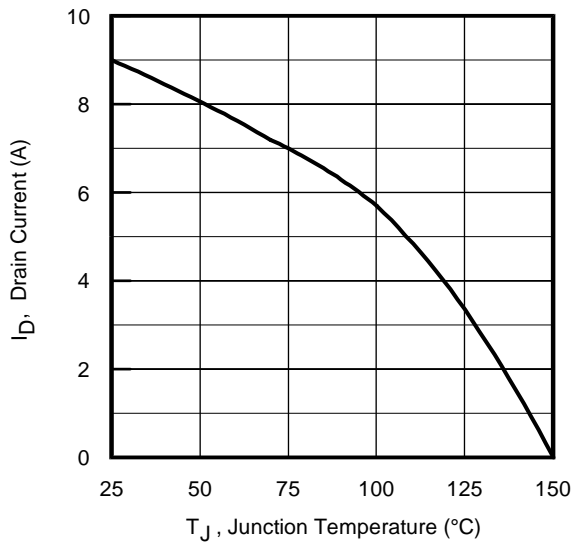

Fig 9. Maximum Drain Current vs. Junction Temperature

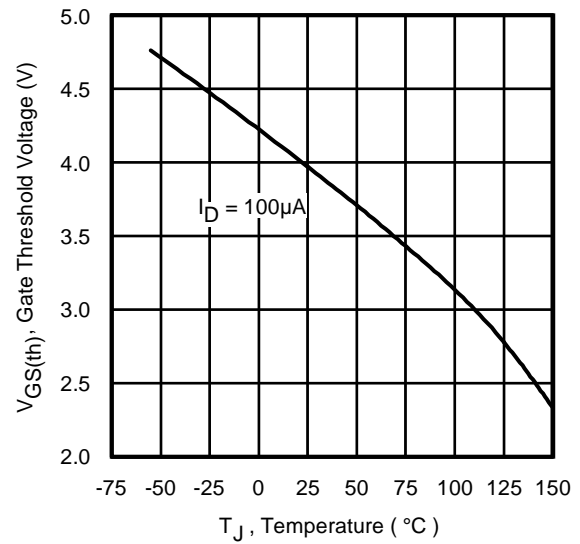

Fig 10. Threshold Voltage vs. Temperature

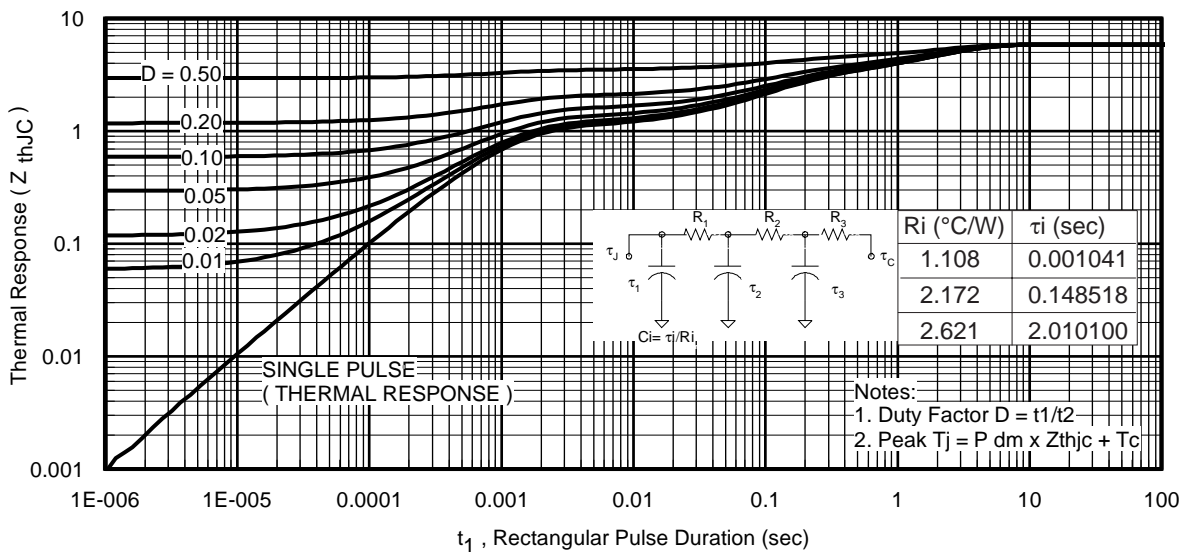

Fig 11. Maximum Effective Transient Thermal Impedance, Junction-to-Case

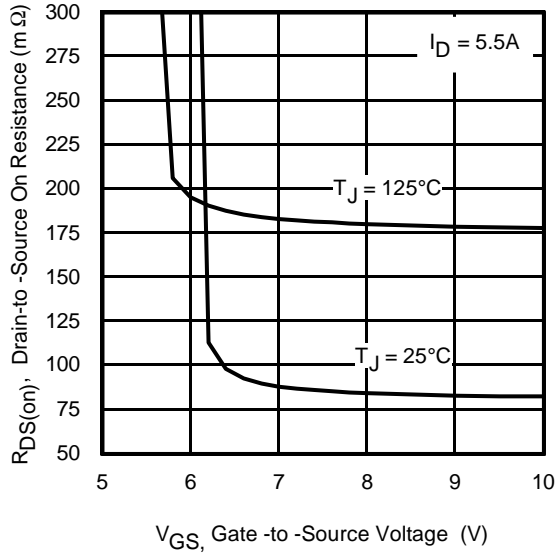

Fig 12. On-Resistance vs. Gate Voltage

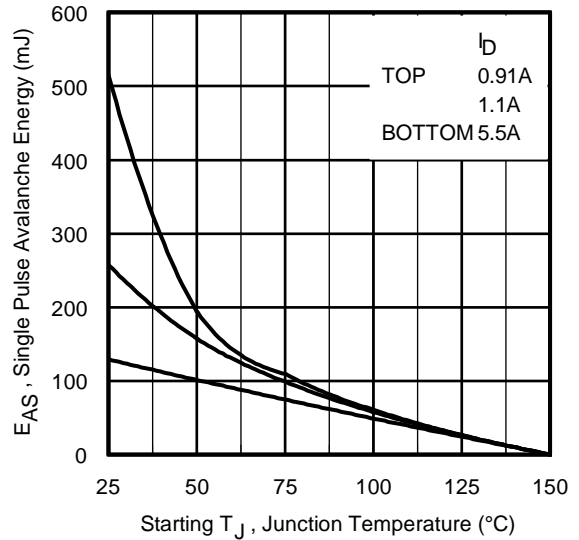

Fig 13a. Maximum Avalanche Energy vs. Drain Current

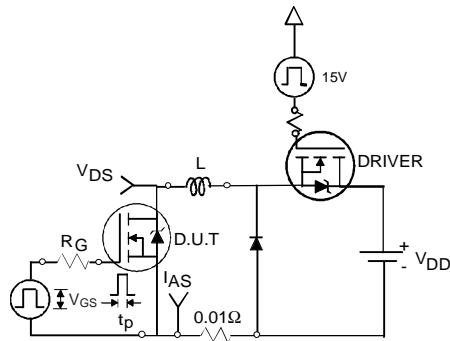

Fig 13b. Unclamped Inductive Test Circuit

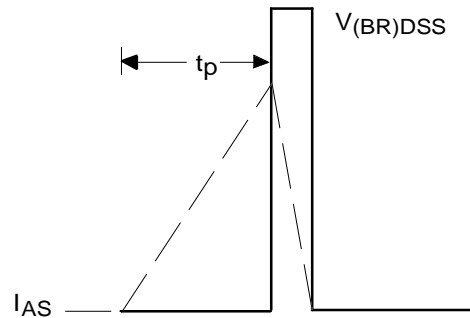

Fig 13c. Unclamped Inductive Waveforms

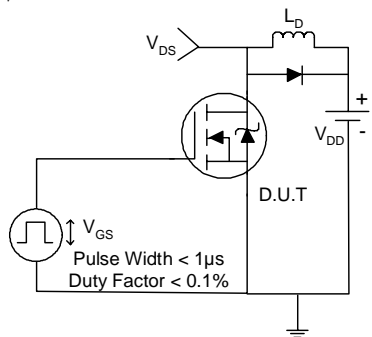

Fig 14a. Switching Time Test Circuit

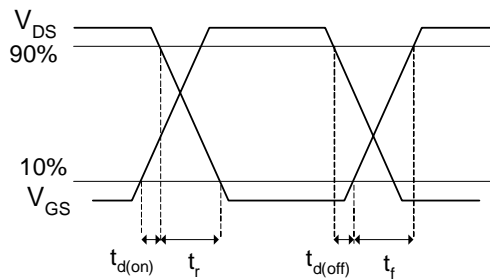

Fig 14b. Switching Time Waveforms

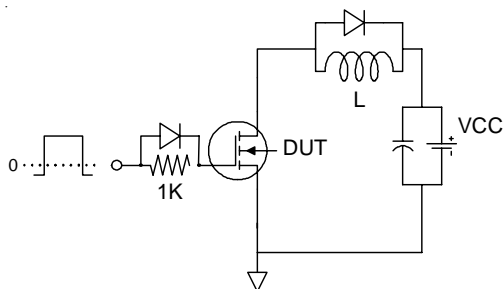

Fig 15a. Gate Charge Test Circuit

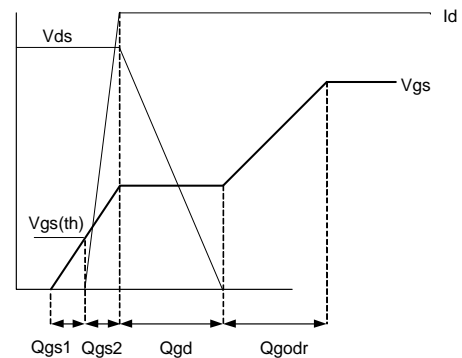
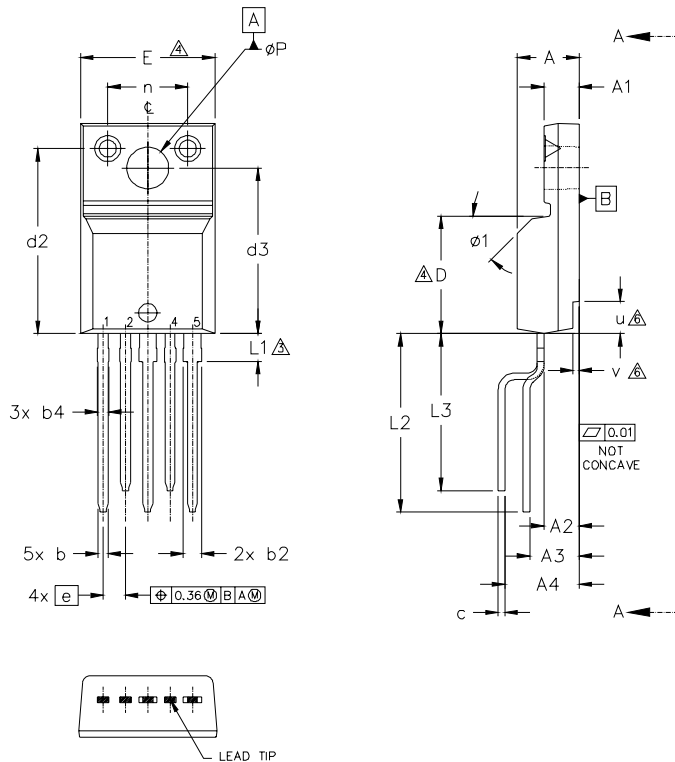

Fig 15b Gate Charge Waveform

IRFI4020H-117P

TO-220 Full-Pak 5-Pin Package Outline, Lead-Form Option 117

(Dimensions are shown in millimeters (inches))



NOTES:

- 1.0 DIMENSIONING AND TOLERANCING AS PER ASME Y14.5 M- 1994.
- 2.0 DIMENSIONS ARE SHOWN IN MILLIMETERS [INCHES].
- 3.0 LEAD DIMENSION AND FINISH UNCONTROLLED IN L1.
- 4.0 DIMENSION D & E DO NOT INCLUDE MOLD FLASH. MOLD FLASH SHALL NOT EXCEED .005" (0.127) PER SIDE. THESE DIMENSIONS ARE MEASURED AT THE OUTER MOST EXTREMES OF THE PLASTIC BODY.
- 5.0 DIMENSION b1, b3, b5 & c1 APPLY TO BASE METAL ONLY.
- 6.0 STEP OPTIONAL ON PLASTIC BODY DEFINED BY DIMENSIONS u & v.
- 7.0 CONTROLLING DIMENSION : INCHES.

| SYMBOL | DIMENSIONS | | | | NOTES |
|--------|-------------|-------|--------|------|-------|
| | MILLIMETERS | | INCHES | | |
| | MIN. | MAX. | MIN. | MAX. | |
| A | 4.57 | 4.83 | .180 | .190 | |
| A1 | 2.57 | 2.83 | .101 | .111 | |
| A2 | 2.51 | 2.85 | .099 | .112 | |
| A3 | 3.73 | 4.24 | .147 | .167 | |
| A4 | 5.79 | 6.29 | .228 | .248 | |
| b | 0.61 | 0.95 | 0.24 | .037 | |
| b1 | 0.56 | 0.90 | .022 | 0.35 | 5 |
| b2 | 1.13 | 1.48 | 0.44 | .058 | |
| b3 | 1.08 | 1.43 | 0.42 | .056 | 5 |
| b4 | 0.76 | 1.06 | .030 | .042 | |
| b5 | 0.71 | 1.01 | .028 | .040 | 5 |
| c | 0.33 | 0.63 | .013 | .025 | |
| c1 | 0.28 | 0.58 | .011 | .023 | 5 |
| D | 8.65 | 9.80 | .341 | .386 | 4 |
| d1 | 15.80 | 16.12 | .622 | .635 | |
| d2 | 13.97 | 14.22 | .550 | .560 | |
| d3 | 12.30 | 12.92 | .484 | .509 | |
| E | 9.63 | 10.63 | .379 | .419 | 4 |

| SYMBOL | DIMENSIONS | | | | NOTES |
|--------|-------------|-------|--------|------|-------|
| | MILLIMETERS | | INCHES | | |
| | MIN. | MAX. | MIN. | MAX. | |
| e | 1.70 | BSC | .067 | BSC | |
| L | 13.20 | 13.73 | .520 | .541 | 3 |
| L1 | 1.91 | 2.31 | .075 | .091 | |
| L2 | 12.7 | 13.46 | .500 | .530 | |
| L3 | 10.92 | 11.68 | .430 | .460 | |
| n | 6.05 | 6.15 | .238 | .242 | |
| phi P | 3.05 | 3.45 | .120 | .136 | |
| u | 2.40 | 2.50 | .094 | .098 | 6 |
| v | 0.40 | 0.50 | .016 | .020 | |
| phi 1 | - | 45° | - | 45° | |

LEAD ASSIGNMENTS

- 1 - SOURCE 2
- 2 - GATE 2
- 3 - DRAIN 2 / SOURCE 1
- 4 - GATE 1
- 5 - DRAIN 1

TO-220 Full-Pak 5-Pin Part Marking Information

EXAMPLE: THIS IS AN IRFI4020H WITH LOT CODE 8024 ASSEMBLED ON WW02.2000 IN THE ASSEMBLY LINE "L"

Note: "P" in assembly line position indicates "Lead Free"

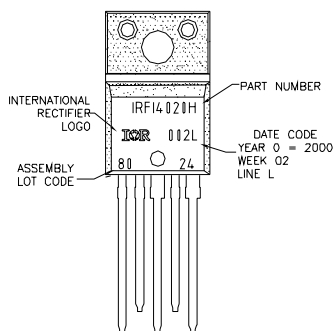

OR

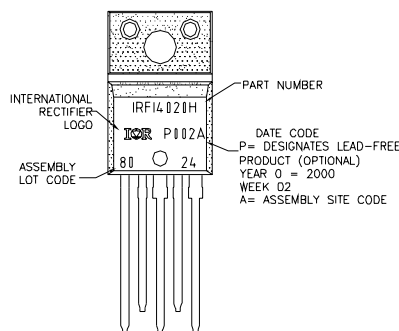

TO-220AB Full-Pak 5-Pin package is not recommended for Surface Mount Application.

Data and specifications subject to change without notice. This product has been designed for the Consumer market. Qualification Standards can be found on IR's Web site.