

SHINDENGEN

Super Fast Recovery Rectifiers

Single

DE3L20U

200V 3A

FEATURES

- SMT
- Low noise
- trr35ns

APPLICATION

- Switching power supply
- DC/DC converter
- Free Wheel
- Home Appliances, Office Equipment
- Telecommunication, Factory Automation

OUTLINE DIMENSIONS

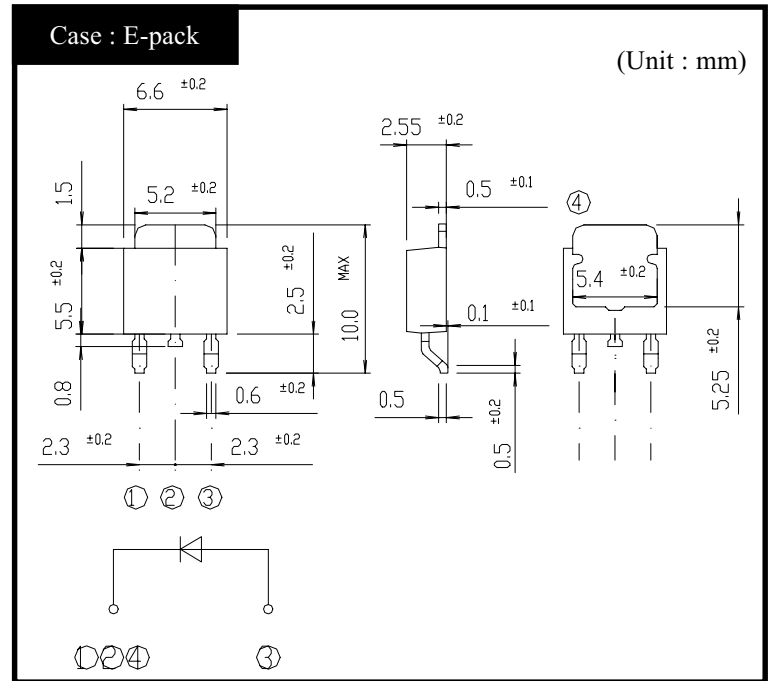

RATINGS

● Absolute Maximum Ratings (If not specified Tc=25°C)

Item	Symbol	Conditions	Ratings	Unit
Storage Temperature	T _{stg}		-55~150	°C
Operating Junction Temperature	T _j		150	°C
Maximum Reverse Voltage	V _{RM}		200	V
Average Rectified Forward Current	I _O	50Hz sine wave, R-load, T _c =113°C	3	A
Peak Surge Forward Current	I _{FSM}	50Hz sine wave, Non-repetitive 1 cycle peak value, T _j =25°C	60	A

● Electrical Characteristics (If not specified Tc=25°C)

Item	Symbol	Conditions	Ratings	Unit
Forward Voltage	V _F	I _F =3A, Pulse measurement	Max.0.98	V
Reverse Current	I _R	V _R =V _{RM} , Pulse measurement	Max.10	μA
Reverse Recovery Time	trr	I _F =0.5A, I _R =1A	Max.35	ns
Thermal Resistance	θ _{jc}	junction to case	Max.12	°C/W

DE3L20U

Forward Voltage

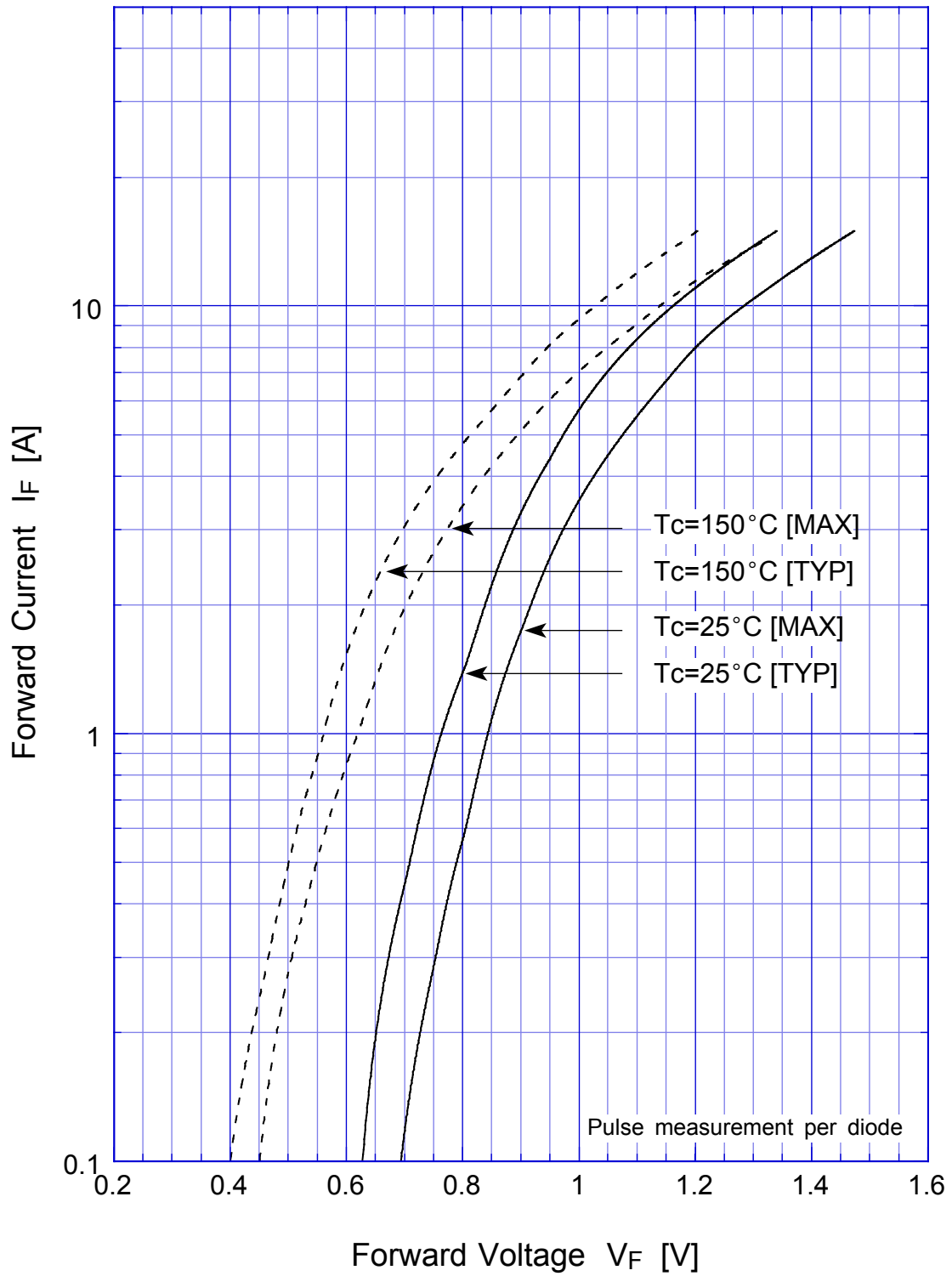

DE3L20U Forward Power Dissipation

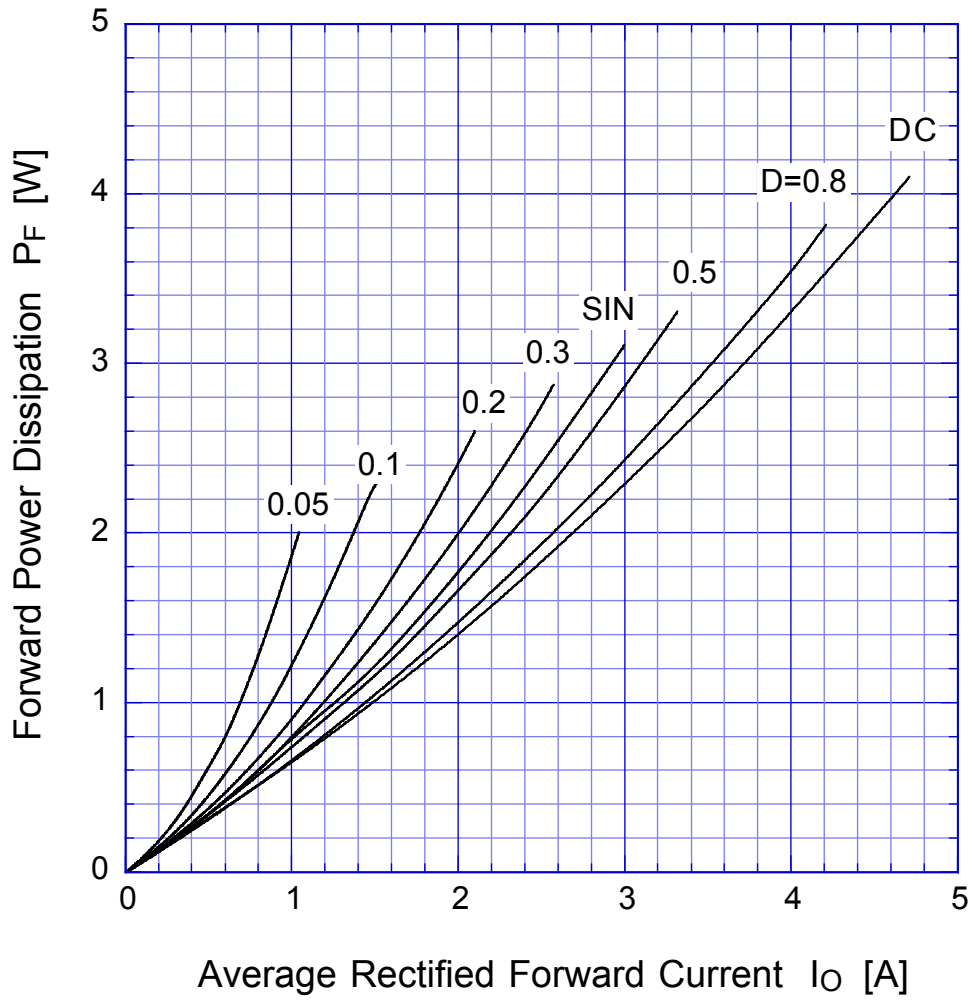

$T_j = 150^\circ\text{C}$

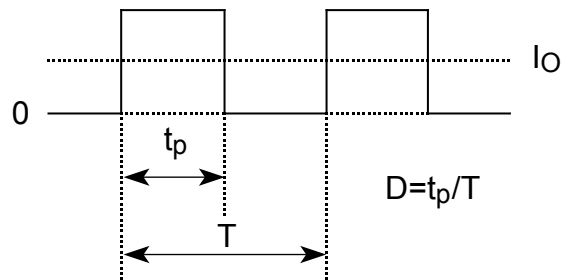

DE3L20U

Derating Curve

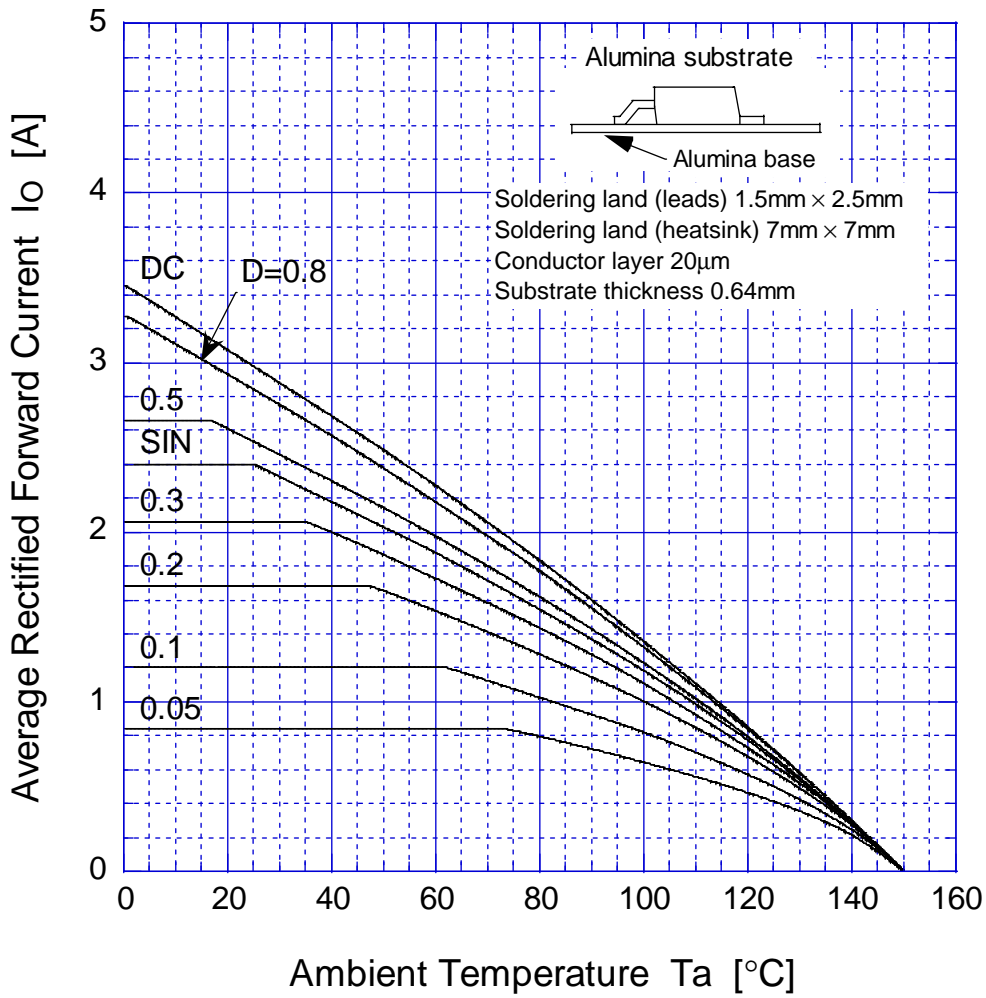

$V_R = 200V$

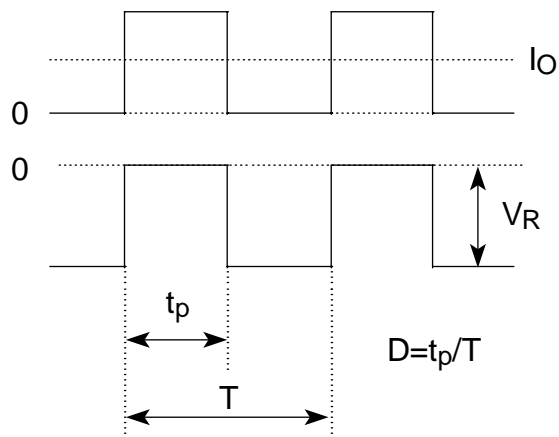

DE3L20U

Derating Curve

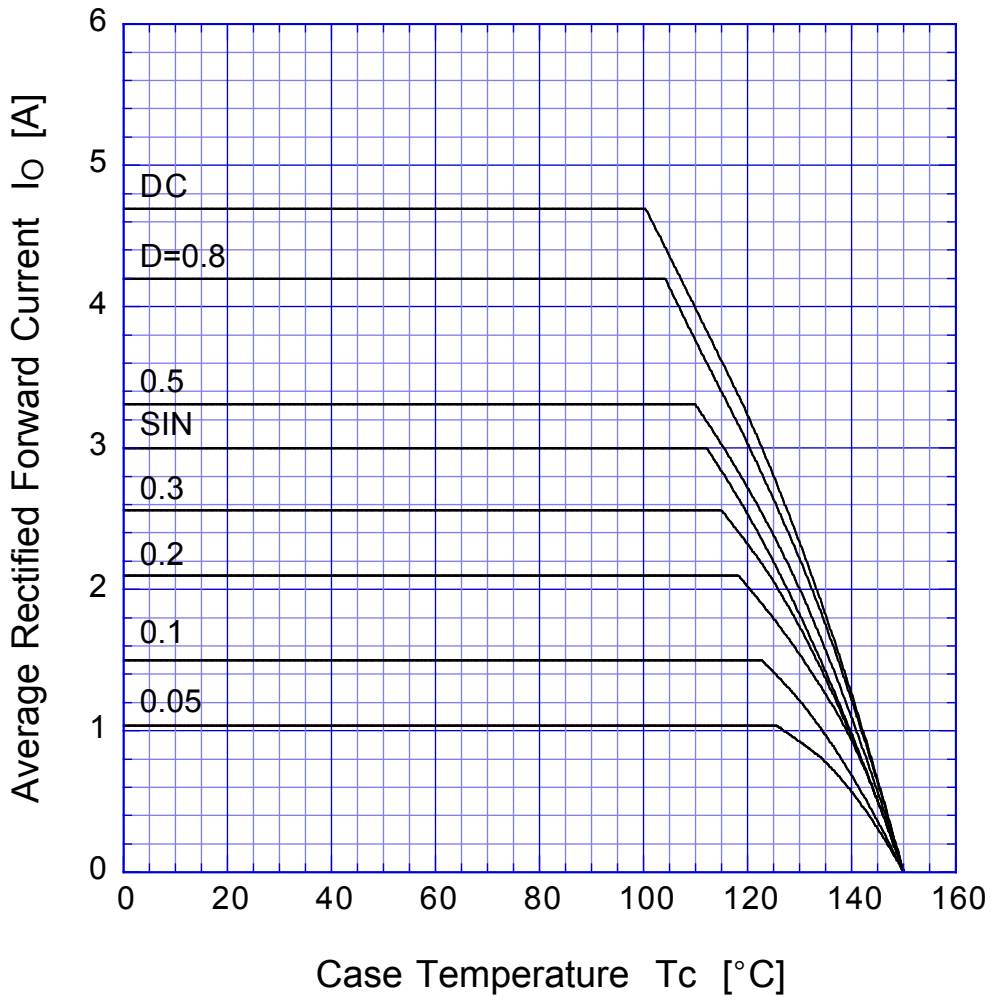

$V_R = 200V$



DE3L20U

Peak Surge Forward Capability

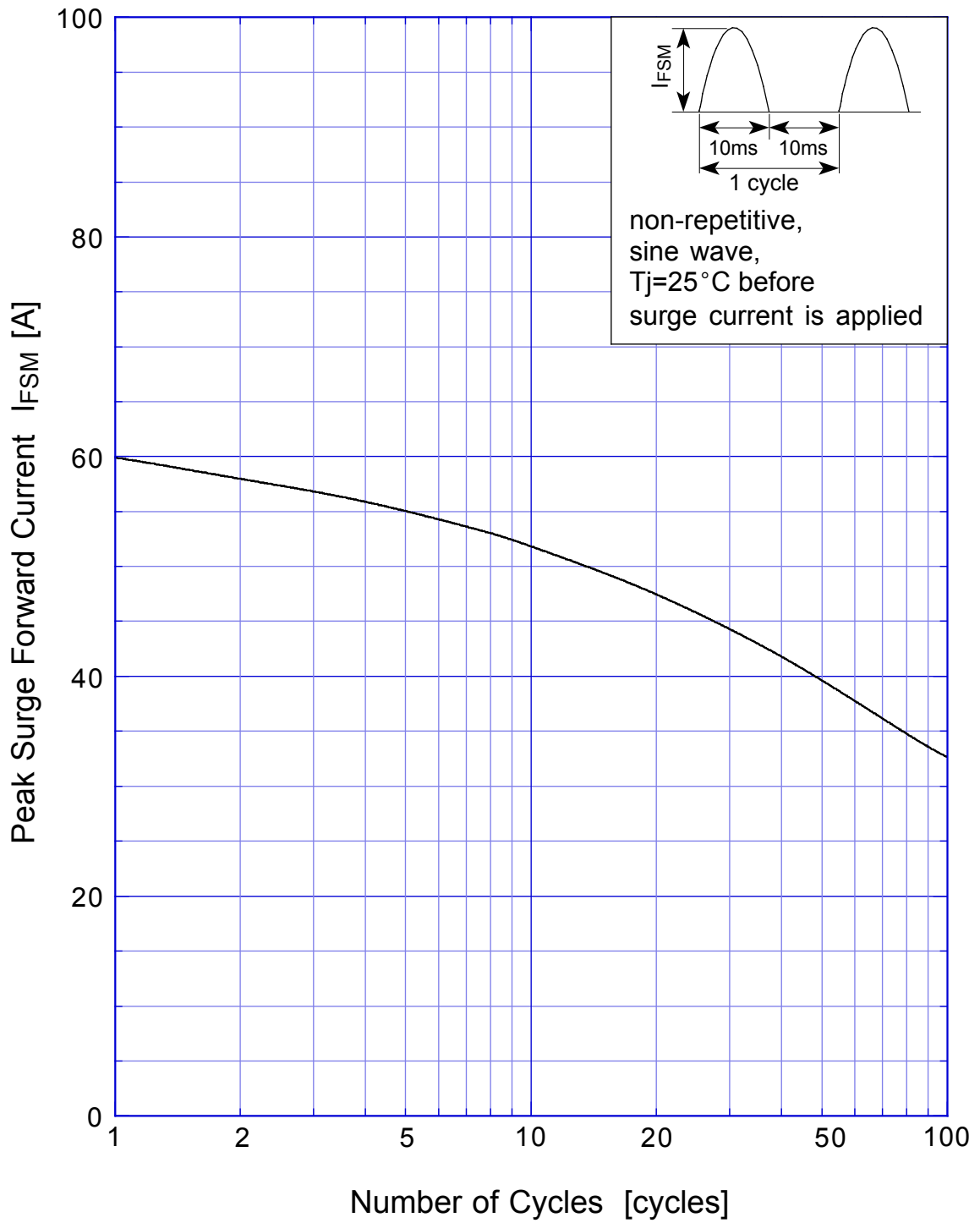

DE3L20U Junction Capacitance

