

Preliminary Data Sheet  
 Subject to Change without Notice  
 November 4, 2005

# A3950

## DMOS Full-Bridge Motor Driver

Package LP, 16-pin TSSOP  
 with Exposed Thermal Pad

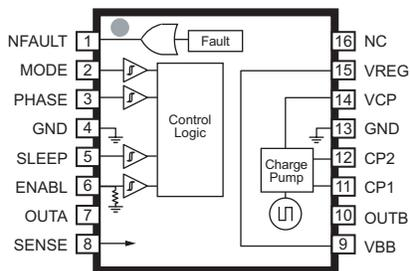

Approximate Scale 1:1



### ABSOLUTE MAXIMUM RATINGS

|  |                |
|--|----------------|
| Load Supply Voltage, $V_{BB}$ .....      | 36 V           |
| Output Current, $I_{OUT}$ .....          | 2.8 A          |
| Sense Voltage, $V_{SENSE}$ .....         | $\pm 500$ mV   |
| $V_{BB}$ to $OUT_x$ .....                | 36 V           |
| $OUT_x$ to SENSE.....                    | 36 V           |
| Logic Input Voltage, $V_{IN}$ .....      | -0.3 to 7 V    |
| Operating Temperature Range              |                |
| Ambient, $T_A$ , Range S.....            | -20°C to 85°C  |
| Junction Temperature, $T_{J(MAX)}$ ..... | 150°C          |
| Storage Temperature, $T_S$ .....         | -40°C to 125°C |

Designed for PWM (pulse width modulated) control of dc motors, the A3950 is capable of peak output currents to  $\pm 2.8$  A and operating voltages to 36 V.

PHASE and ENABLE input terminals are provided for use in controlling the speed and direction of a dc motor with externally applied PWM control signals. Internal synchronous rectification control circuitry is provided to lower power dissipation during PWM operation.

Internal circuit protection includes motor lead short-to-supply/short-to-ground, thermal shutdown with hysteresis, undervoltage monitoring of  $V_{BB}$  and  $V_{CP}$ , and crossover-current protection.

The A3950 is supplied in a thin profile (<1.2 mm overall height) 16-pin TSSOP package with exposed thermal pad (package LP). It is lead (Pb) free with 100% matte tin leadframe plating.

### FEATURES

- Low  $R_{DS(on)}$  outputs
- Overcurrent protection
- Motor lead short-to-supply protection
- Short-to-ground protection
- Sleep function
- Synchronous rectification
- Diagnostic output
- Internal UVLO
- Crossover-current protection



Use the following complete part numbers when ordering:

| Part Number  | Packing                       |
|--------------|-------------------------------|
| A3950SLP-T   | 96 pieces/tube                |
| A3950SLPTR-T | 13-in. reel, 4000 pieces/reel |

**Functional Block Diagram**

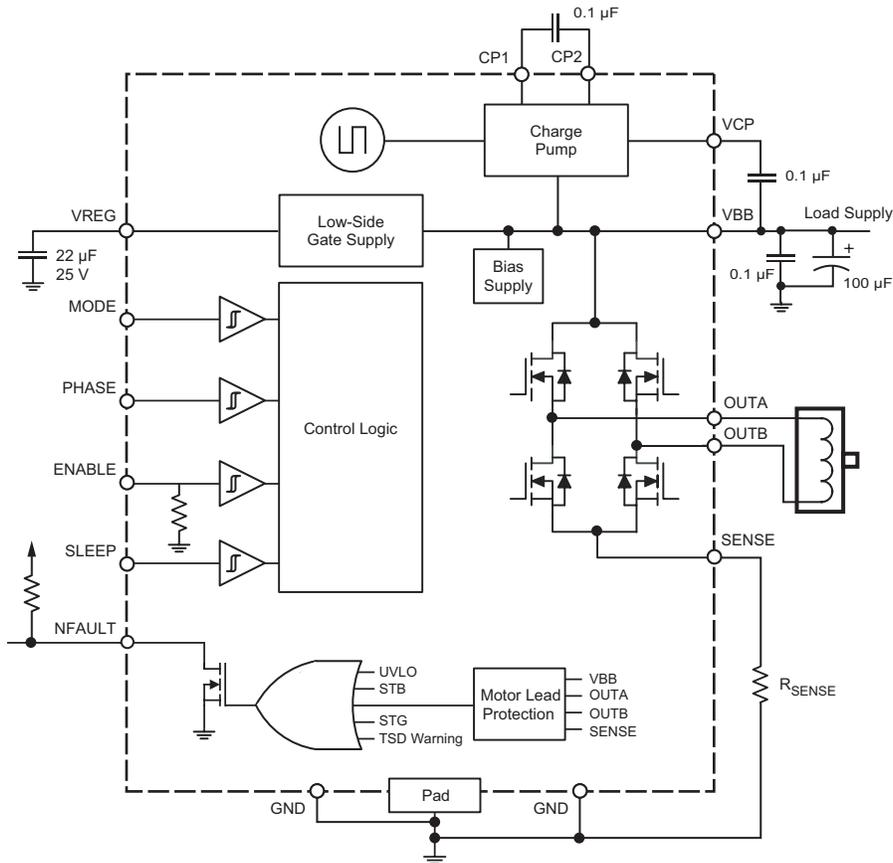

Control Logic Table<sup>1</sup>

| Pin   |        |      |       |      |      | Function  |
|-------|--------|------|-------|------|------|---|
| PHASE | ENABLE | MODE | SLEEP | OUTA | OUTB |   |
| 1     | 1      | X    | 1     | H    | L    | Forward   |
| 0     | 1      | X    | 1     | L    | H    | Reverse   |
| X     | 0      | 1    | 1     | L    | L    | Brake (slow decay)                                |
| 1     | 0      | 0    | 1     | L    | H    | Fast Decay Synchronous Rectification <sup>2</sup> |
| 0     | 0      | 0    | 1     | H    | L    | Fast Decay Synchronous Rectification <sup>2</sup> |
| X     | X      | X    | 0     | Z    | Z    | Sleep Mode  |

<sup>1</sup>X indicates "don't care," Z indicates high impedance.

<sup>2</sup>To prevent reversal of current during fast decay synchronous rectification, outputs go to the high impedance state as the current approaches 0 A.

**ELECTRICAL CHARACTERISTICS at  $T_J = 25^\circ\text{C}$ ,  $V_{BB} = 8$  to  $36\text{ V}$ , unless noted otherwise**

| Characteristics                        | Symbol        | Test Conditions  | Min. | Typ.  | Max. | Units            |
|--|---------------|--|------|-------|------|------------------|
| Motor Supply Current                   | $I_{BB}$      | $f_{PWM} < 50\text{ kHz}$  | -    | 6     | 8.5  | mA               |
|  |               | Charge pump on, outputs disabled                                     | -    | 3     | 4.5  | mA               |
|  |               | Sleep mode   | -    | -     | 10   | $\mu\text{A}$    |
| PHASE, ENABLE, MODE Input Voltage      | $V_{IH}$      |  | 2.0  | -     | -    | V                |
|  | $V_{IL}$      |  | -    | -     | 0.8  | V                |
| SLEEP Input Voltage                    | $V_{IH}$      |  | 2.7  | -     | -    | V                |
|  | $V_{IL}$      |  | -    | -     | 0.8  | V                |
| PHASE, MODE Input Current <sup>1</sup> | $I_{IH}$      | $V_{IN} = 2.0\text{ V}$  | -    | <1.0  | 20   | $\mu\text{A}$    |
|  | $I_{IL}$      | $V_{IN} = 0.8\text{ V}$  | -    | <-2.0 | -20  | $\mu\text{A}$    |
| ENABLE Input Current                   | $I_{IH}$      | $V_{IN} = 2.0\text{ V}$  | -    | 40    | 100  | $\mu\text{A}$    |
|  | $I_{IL}$      | $V_{IN} = 0.8\text{ V}$  | -    | 16    | 40   | $\mu\text{A}$    |
| SLEEP Input Current                    | $I_{IH}$      | $V_{IN} = 2.7\text{ V}$  | -    | 27    | 50   | $\mu\text{A}$    |
|  | $I_{IL}$      | $V_{IN} = 0.8\text{ V}$  | -    | <1    | 10   | $\mu\text{A}$    |
| NFAULT Output Voltage                  | $V_{OL}$      | $I_{sink} = 1.0\text{ mA}$   | -    | -     | 0.4  | V                |
| Input Hysteresis, except SLEEP         | $V_{IHys}$    |  | 100  | 150   | 200  | mV               |
| Output On Resistance                   | $R_{DS(on)}$  | Source driver, $I_{OUT} = -2.8\text{ A}$ , $T_J = 25^\circ\text{C}$  | -    | 0.35  | 0.48 | $\Omega$         |
|  |               | Source driver, $I_{OUT} = -2.8\text{ A}$ , $T_J = 125^\circ\text{C}$ | -    | 0.55  | 0.8  | $\Omega$         |
|  |               | Sink driver, $I_{OUT} = 2.8\text{ A}$ , $T_J = 25^\circ\text{C}$     | -    | 0.3   | 0.43 | $\Omega$         |
|  |               | Sink driver, $I_{OUT} = 2.8\text{ A}$ , $T_J = 125^\circ\text{C}$    | -    | 0.45  | 0.7  | $\Omega$         |
| Propagation Delay Time                 | $t_{pd}$      | PWM, change to source or sink ON                                     | -    | 600   | -    | ns               |
|  |               | PWM, change to source or sink OFF                                    | -    | 100   | -    | ns               |
| Crossover Delay                        | $t_{COD}$     |  | -    | 500   | -    | ns               |
| <b>Protection Circuitry</b>            |               |  |      |       |      |                  |
| UVLO Threshold                         | $V_{UV}$      | $V_{BB}$ increasing  | -    | 6.5   | -    | V                |
| UVLO Hysteresis                        | $V_{UVHys}$   |  | -    | 250   | -    | mV               |
| Overcurrent Threshold <sup>2</sup>     | $I_{OCP}$     |  | 3    | -     | -    | A                |
| Overcurrent Protection Period          | $t_{OCP}$     |  | -    | 1.2   | -    | ms               |
| Thermal Warning Temperature            | $T_{JW}$      | Temperature increasing   | -    | 160   | -    | $^\circ\text{C}$ |
| Thermal Warning Hysteresis             | $T_{JWHys}$   | Recovery = $T_{JW} - T_{JWHys}$                                      | -    | 15    | -    | $^\circ\text{C}$ |
| Thermal Shutdown Temperature           | $T_{JTSD}$    | Temperature increasing   | -    | 175   | -    | $^\circ\text{C}$ |
| Thermal Shutdown Hysteresis            | $T_{JTSDHys}$ | Recovery = $T_{JTSD} - T_{JTSDHys}$                                  | -    | 15    | -    | $^\circ\text{C}$ |

<sup>1</sup>For input and output current specifications, negative current is defined as coming out of (sourcing) the specified device pin.

<sup>2</sup>Overcurrent protection is tested at  $25^\circ\text{C}$  in a restricted range and guaranteed by characterization.

**THERMAL CHARACTERISTICS may require derating at maximum conditions, see application information**

| Characteristic             | Symbol          | Test Conditions*   | Value | Units              |
|----------------------------|-----------------|--|-------|--------------------|
| Package Thermal Resistance | $R_{\theta JA}$ | 4-layer PCB based on JEDEC standard  | 34    | $^\circ\text{C/W}$ |
|                            |                 | 2-layer PCB with 3.8 in. <sup>2</sup> copper both sides, connected by thermal vias | 43    | $^\circ\text{C/W}$ |

\*Additional thermal data available on the Allegro Web site.

Timing Diagram: PWM Control

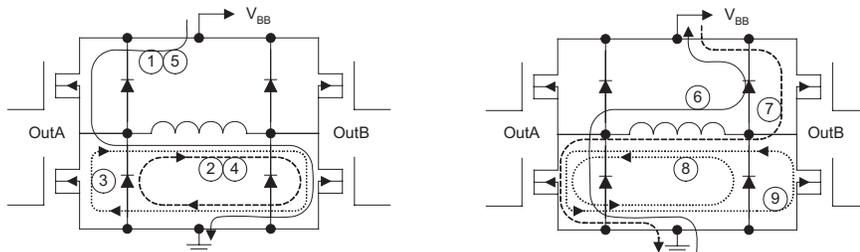
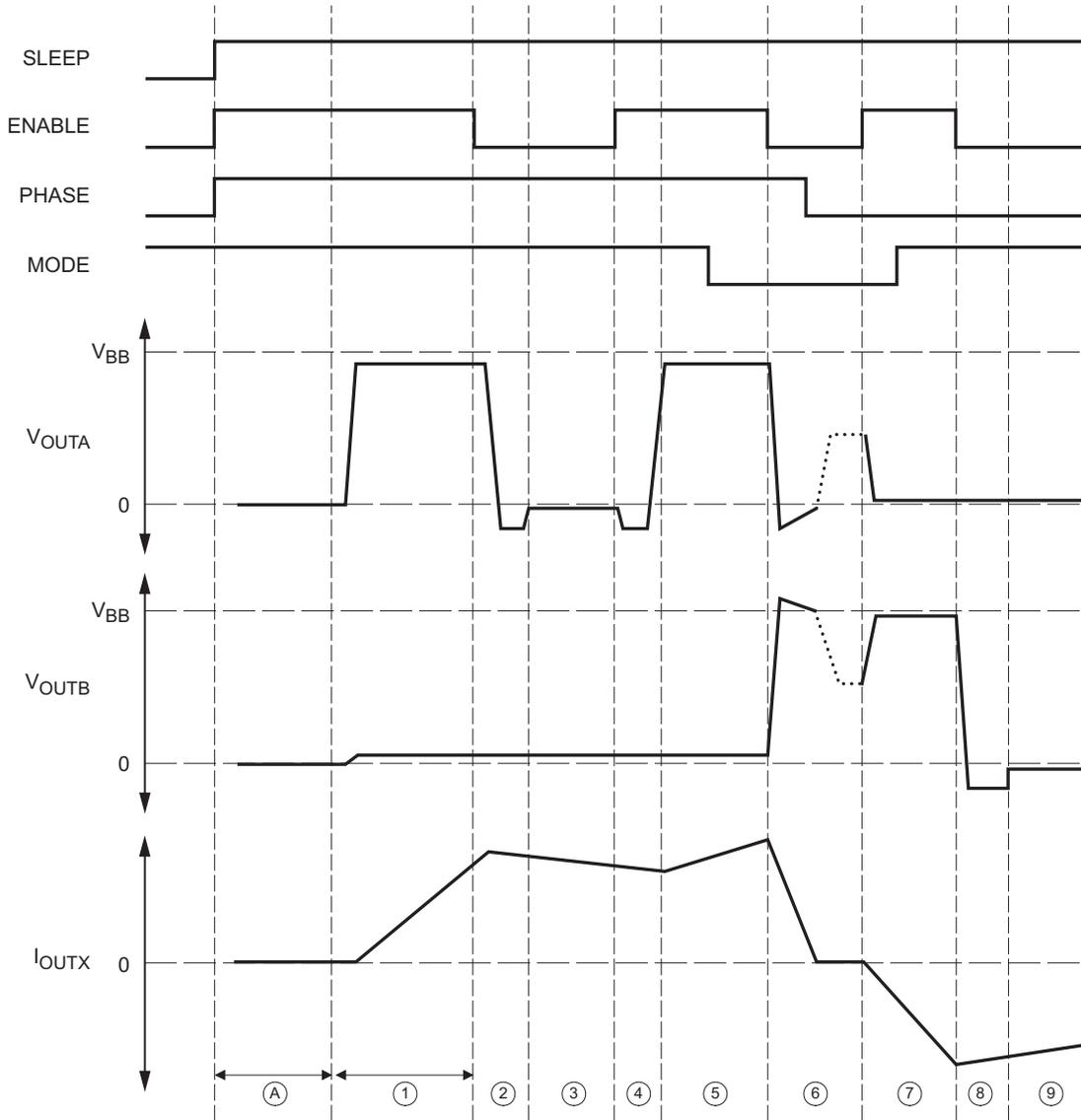

(A) Charge pump and VREG power-on delay ( $\approx 200 \mu\text{s}$ )

Timing Diagram: Overcurrent Control

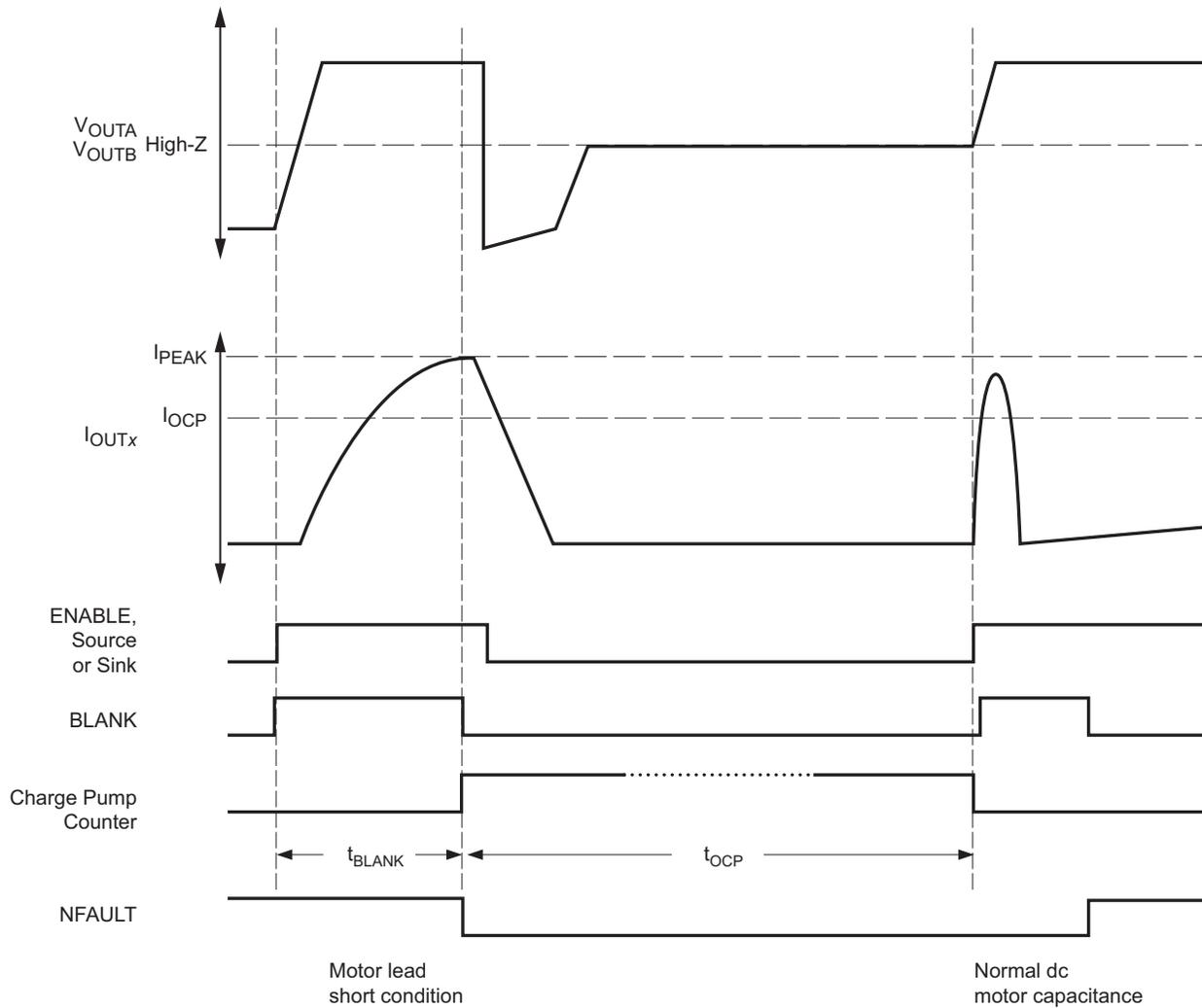

## Functional Description

**VREG.** This supply voltage is used to run the sink-side DMOS outputs. VREG is internally monitored and in the case of a fault condition, the outputs of the device are disabled. The VREG pin should be decoupled with a 0.22  $\mu\text{F}$  capacitor to ground.

**Charge Pump.** The charge pump is used to generate a supply above  $V_{\text{BB}}$  to drive the source-side DMOS gates. A 0.1  $\mu\text{F}$  ceramic monolithic capacitor should be connected between CP1 and CP2 for pumping purposes. A 0.1  $\mu\text{F}$  ceramic monolithic capacitor should be connected between VCP and VBB to act as a reservoir to run the high-side DMOS devices. The VCP voltage level is internally monitored and, in the case of a fault condition, the outputs of the device are disabled.

**Shutdown.** In the event of a fault due to excessive junction temperature, or low voltage on VCP or VREG, the outputs of the device are disabled until the fault condition is removed. At power-on the UVLO circuit disables the drivers.

**Sleep Mode.** Control input SLEEP is used to minimize power consumption when the A3950 not in use. This disables much of the internal circuitry, including the regulator and charge pump. A logic low setting puts the device into Sleep mode, and a logic high setting allows normal operation. After coming out of Sleep mode, provide a 1 ms interval before applying PWM signals, to allow the charge pump to stabilize.

**MODE.** Control input MODE is used to toggle between fast decay mode and slow decay mode. A logic high puts the device in slow decay mode. Synchronous rectification is always enabled.

**Braking.** The braking function is implemented by driving the device in slow decay mode via the MODE setting and

applying an enable chop command. Because it is possible to drive current in both directions through the DMOS switches, this configuration effectively shorts out the motor generated BEMF as long as the ENABLE chop mode is asserted. The maximum current can be approximated by  $V_{\text{BEMF}}/R_{\text{L}}$ . Care should be taken to insure that the maximum ratings of the device are not exceeded in worse case braking situations: high speed and high-inertia loads.

**Overcurrent Protection.** The voltage on the output pins relative to supply are monitored to ensure that the motor lead is not shorted to supply or ground. If a short is detected, the full-bridge outputs are turned off, flag NFAULT is driven low, and a 1.2 ms fault timer is started.

After this 1.2 ms period,  $t_{\text{OCP}}$ , the device will then be allowed to follow the input commands and another turn-on is attempted. If there is still a fault condition, the cycle repeats. If, after  $t_{\text{OCP}}$  expires, it is determined that the short condition is not present, the NFAULT pin is released and normal operation resumes.

**Diagnostic Output.** The NFAULT pin signals a problem with the chip via an open drain output. A motor fault, under-voltage condition, or  $T_{\text{J}} > 160^{\circ}\text{C}$  will drive the pin active low. This output is not valid when SLEEP puts the device into minimum power dissipation mode.

**TSD.** Two die temperature monitors are integrated on the chip. As die temperature increases towards the maximum, a thermal warning signal will be triggered at  $160^{\circ}\text{C}$ . This fault drives the NFAULT low, but does not disable the operation of the chip. If the die temperature increases further, to approximately  $175^{\circ}\text{C}$ , the full-bridge outputs will be disabled until the internal temperature falls below a hysteresis of  $15^{\circ}\text{C}$ .

## Applications Information

**Power Dissipation.** First order approximation of power dissipation in the A3950 can be calculated by first examining the power dissipation in the full-bridge during each of the operation modes. The A3950 features synchronous rectification, a feature that effectively shorts out the body diode by turning on the low  $R_{DS(on)}$  DMOS driver during the decay cycle. This significantly reduces power dissipation in the full-bridge. In order to prevent shoot-through, where both source and sink driver are on at the same time, the A3950 implements a 500 ns typical crossover delay time. For this period, the body diode in the decay current path conducts the current until the DMOS driver turns on. This does affect

power dissipation and may need to be considered in high current, high ambient temperature applications. In addition, motor parameters and switching losses can add power dissipation that could affect critical applications.

**Drive Current.** This current path is through source DMOS driver, motor winding, and sink DMOS driver. Power dissipation is  $I^2R$  losses in one source and one sink DMOS driver, as shown in the following equation:

$$P_D = I^2 (R_{DS(on)Source} + R_{DS(on)Sink}) \quad (1)$$

**Fast Decay with Synchronous Rectification.** This decay mode is equivalent to a phase change where the opposite drivers are switched on. When in fast decay, the motor current is not allowed to go negative (direction change). Instead, as the current approaches zero, the drivers turn off. The power calculation is the same as the drive current calculation, equation 1:

**Slow Decay SR (Brake Mode).** In this decay mode, both sink drivers turn on, allowing the current to circulate through the sink drivers and the load. Power dissipation is  $I^2R$  losses in the two sink DMOS drivers:

$$P_D = I^2 (2 \times R_{DS(on)Sink}) \quad (2)$$

**Layout.** The printed circuit board should include a heavy ground plane. For optimum electrical and thermal performance, the exposed thermal pad of the device should be soldered directly to an exposed copper area directly under the device. The load supply pin, VBB, should be decoupled with an electrolytic capacitor (typically 100  $\mu$ F) in parallel with a ceramic capacitor placed as close as possible to the device. The ceramic capacitors between VCP and VBB, connected to VREG, and between CP1 and CP2, should be as close to the pins of the device as possible, in order to minimize lead inductance.

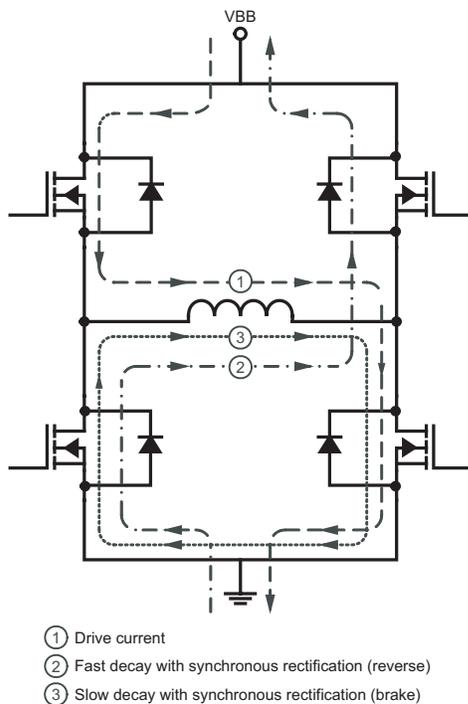

Figure 1. Current Decay Patterns

**Ground.** A star ground should be located as close to the A3950 as possible. The copper ground plane directly under the exposed thermal pad makes a good location for the star ground point. The exposed pad can be connected to ground for this purpose.

**SENSE Pin.** A low value resistor can be placed between the SENSE pin and ground for current sensing purposes. To minimize ground-trace IR drops in sensing the output current

level, the current sensing resistor should have an independent ground return to the star ground point. This trace should be as short as possible. For low value sense resistors, the IR drops in the PCB can be significant, and should be taken into account.

When selecting a value for the sense resistor be sure not to exceed the maximum voltage on the SENSE pin of  $\pm 500$  mV.

**Terminal List Table**

| Name   | Number | Description   |
|--------|--------|---|
| NFAULT | 1      | Fault output, open drain                                  |
| MODE   | 2      | Logic input   |
| PHASE  | 3      | Logic input for direction control                         |
| GND    | 4      | Ground  |
| SLEEP  | 5      | Logic input   |
| ENABLE | 6      | Logic input   |
| OUTA   | 7      | DMOS full-bridge output A                                 |
| SENSE  | 8      | Power return  |
| VBB    | 9      | Load supply voltage                                       |
| OUTB   | 10     | DMOS full-bridge output B                                 |
| CP1    | 11     | Charge pump capacitor terminal                            |
| CP2    | 12     | Charge pump capacitor terminal                            |
| GND    | 13     | Ground  |
| VCP    | 14     | Reservoir capacitor terminal                              |
| VREG   | 15     | Regulator decoupling terminal                             |
| NC     | 16     | No connection   |
| Pad    | –      | Exposed pad for thermal dissipation connect to pins 4, 13 |

LP Package, 16-Pin TSSOP with Exposed Thermal Pad

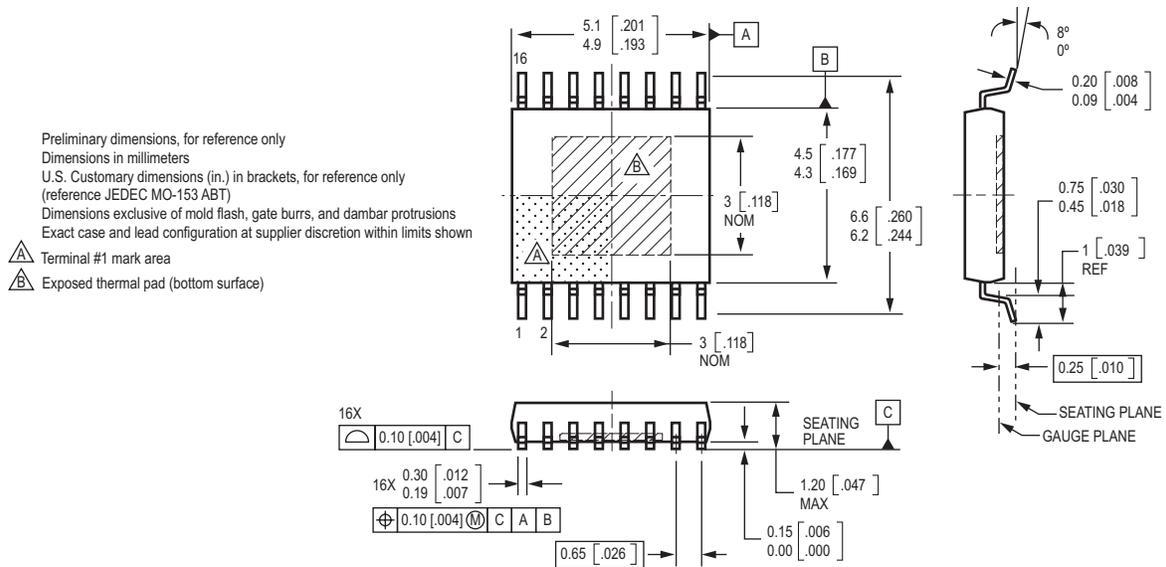

The products described here are manufactured under one or more U.S. patents or U.S. patents pending.

Allegro MicroSystems, Inc. reserves the right to make, from time to time, such departures from the detail specifications as may be required to permit improvements in the performance, reliability, or manufacturability of its products. Before placing an order, the user is cautioned to verify that the information being relied upon is current.

Allegro products are not authorized for use as critical components in life-support devices or systems without express written approval.

The information included herein is believed to be accurate and reliable. However, Allegro MicroSystems, Inc. assumes no responsibility for its use; nor for any infringement of patents or other rights of third parties which may result from its use.